



**SERVICE INSTRUCTIONS
AND PARTS CATALOG**



TAITO CORPORATION

1. Name of Part (See Figs. 1 and 2)

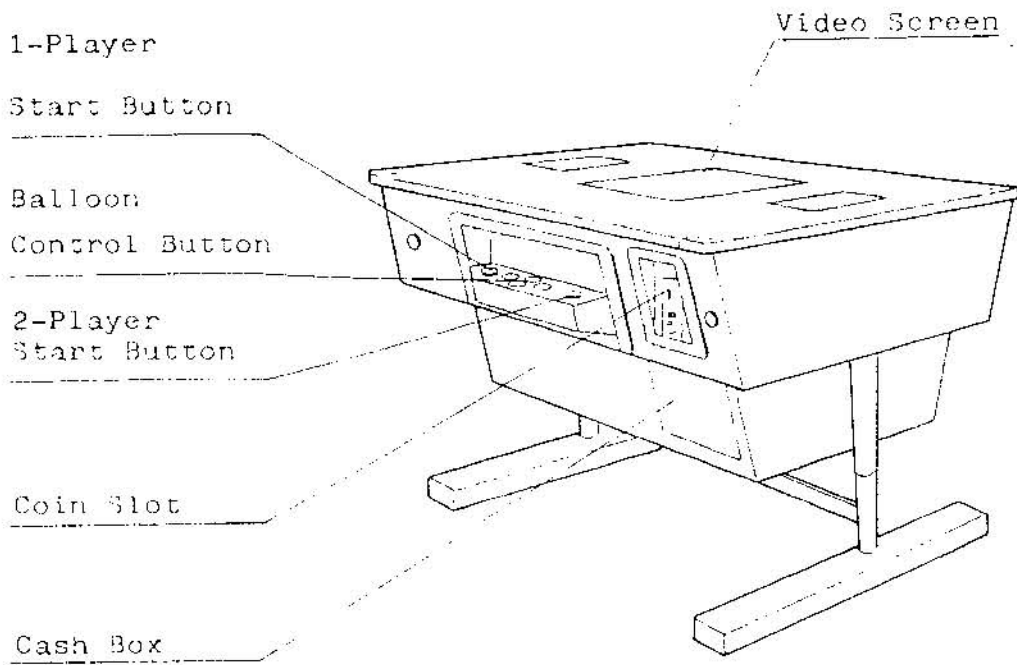

Fig. 1

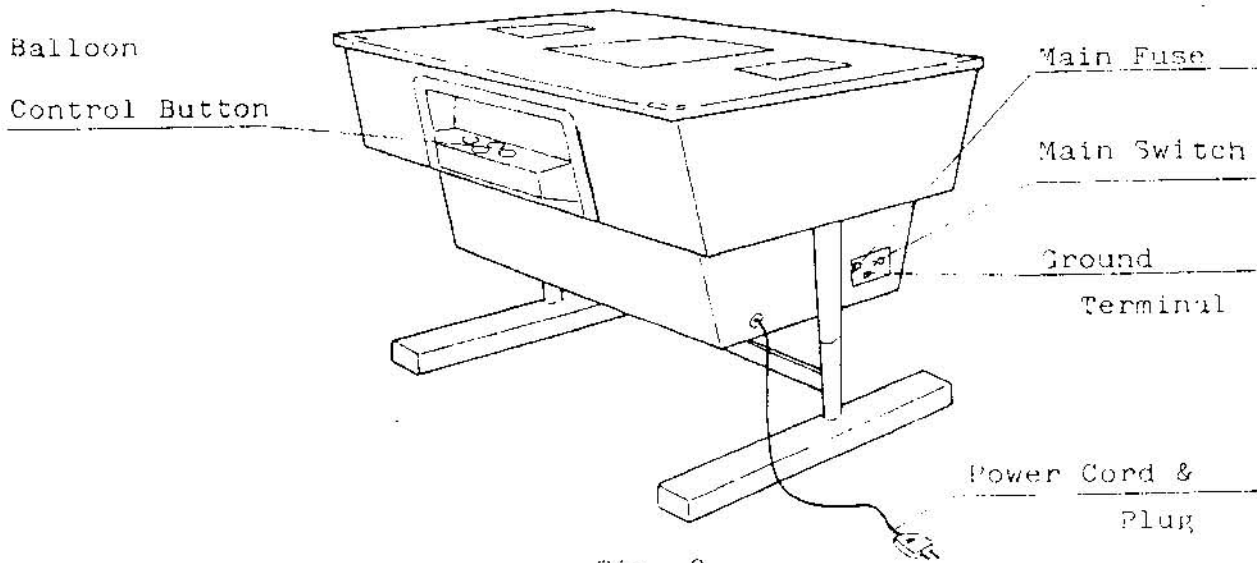

Fig. 2

2. Transportation and Installation

o Avoid rough handling in transportation; the picture tube is fragile.

o Taito " CRAZY BALLOON " is for indoor use.

o Install the machine indoors only.

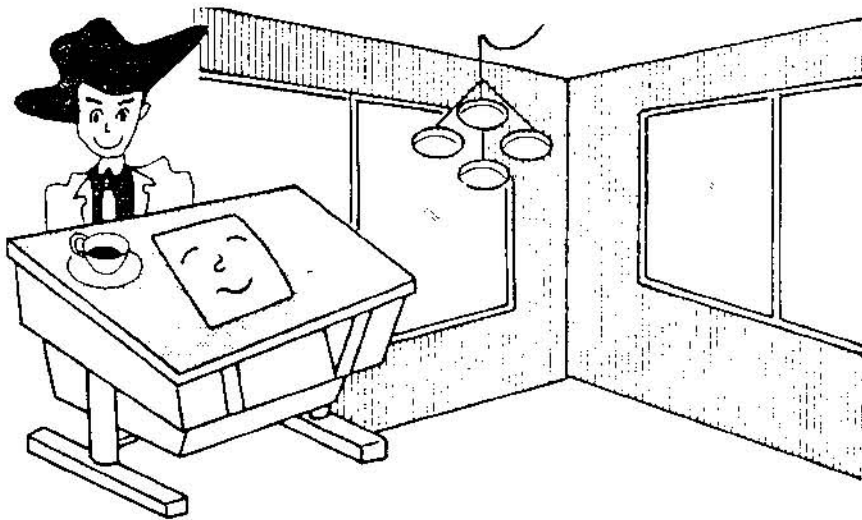

o Do not install the machine outdoors.

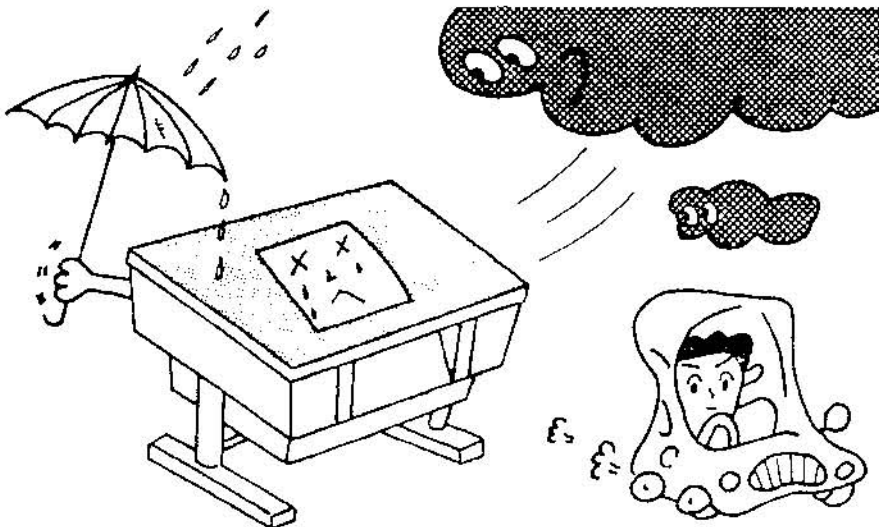

- o Install the machine on a flat-surfaced floor and provided suitable space around the machine.

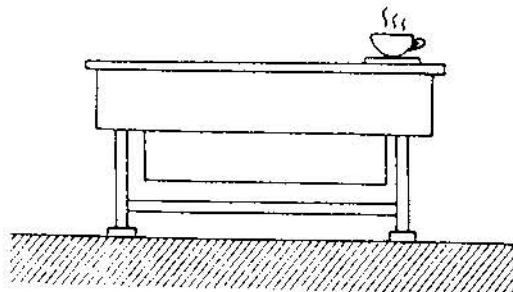
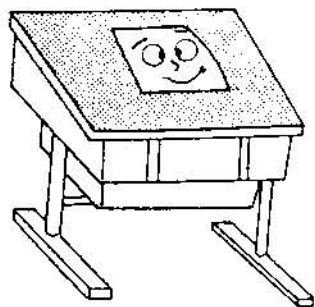

(Floor)

- o Do not install the machine in location with vibration.

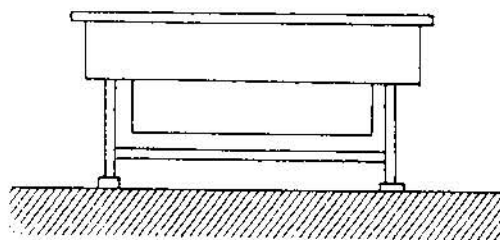
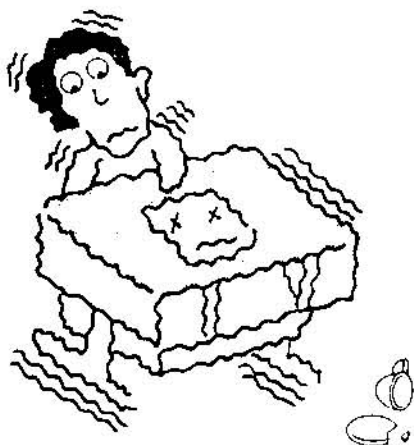

(Floor)

- o Do not install the machine in dangerous places viewed from the angle of disaster prevention.

(Emergency Exit)

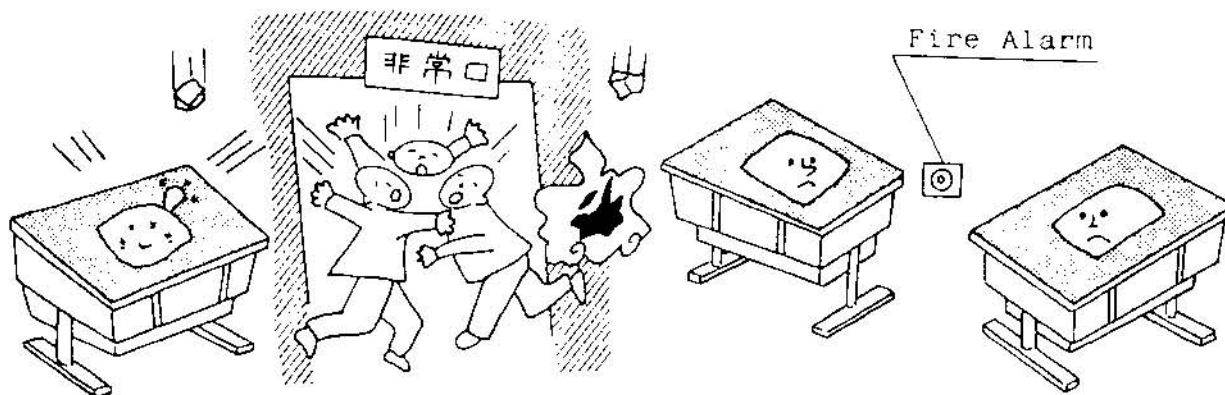

- o Do not install the machine in location with exposure to direct sunlight or excessive heat in order to prevent the unit from rising internal temperature. Also, do not install the machine in humid or dusty places.

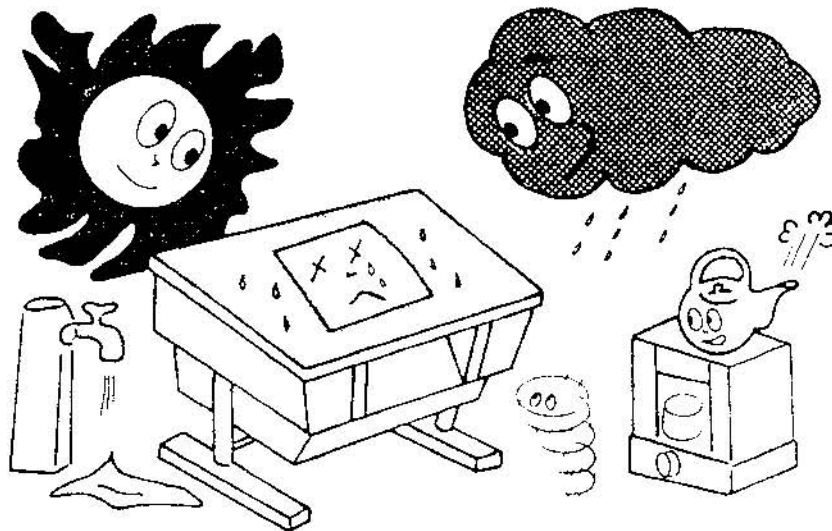

- o Connections may be loosen during transportation. Ensure all connections to the PCB's and the connectors are secure before plugging in.
- o Never fail to connect the ground terminal.
- o Insert the power plug into a proper outlet and turn the power switch on.
- o In case the machine does not work properly after the power switch was turned on. Make sure the voltage properly exists on each output line. (See " Adjustments on Switching Regulator Board page 5 and page 9 of this manual."

3. Handling Note and Warning

Note:

- o Erroneous picture may appear on the screen when the machine is first switched on. This typical of the CPU circuitry, and will correct itself automatically when the power switch is off and on.
- o No picture may appear on the screen for a while when the machine is switched on at a subzero temperature in the location. This is also typical of the solid-state circuitry.

Warning:

- o Taito " CRAZY BALLOON " uses a CPU and the latest solid-state circuitry for long life, however, as with sophisticated electronic equipment certain precautions must be observed to avoid damage.
 - (1) Do not attempt to service with ordinary testing equipment, since the internal voltage of the testing equipment may cause damage to the circuitry.
 - (2) Never connect or disconnect any of the solid-state modules while the power is on.

4. Routine Maintenance

- o Because of the solid-state electronic circuitry, this machine should require very little maintenance and only occasional adjustments, however, it is necessary to take measures to insure its daily safety.

5. Play Instructions

- o Insert coin(s). 1 play : 4 balloons (adjustable)
- o Select game for one or two players.
- o After the game-start music is heard, play begins with the picture shown in Fig. 3.
- o Avoid all obstacles and move balloon from start to goal.
- o In two player mode, play alternates between the two.

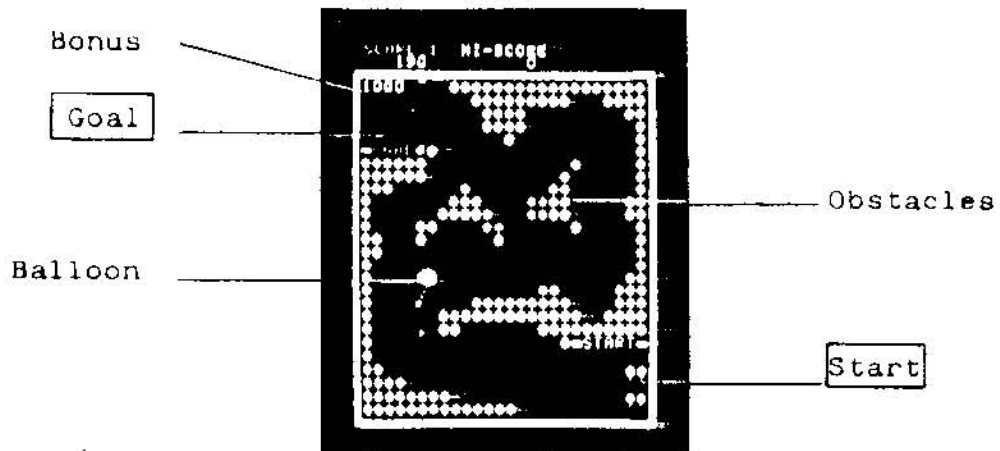

Fig. 3
(Play Mode)

- o Balloon passing through obstacles scores the following points:

Yellow Obstacle	500 points
Pink Obstacle	300 points
Green Obstacle	200 points
Blue Obstacle	10 points

- o Elapsed time decreases bonus points by 20 points increments.

- o Balloon will burst when kept in the same position for 5 seconds.

(See Fig. 4)

Balloon will burst by this

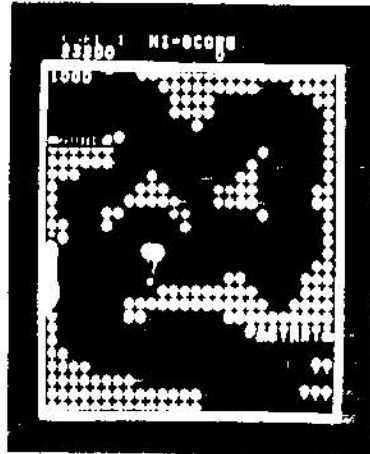

Fig. 4

- o Frame changes after each goal.
- o One balloon is awarded when score reaches 10,000 points.
- o Game is over when 4th balloon burst. (Four balloons per game.)
- o Up to 9 coins can be credited, but the credits will be cleared by vandalism.
- o High-scorer's name can be registered on the screen.
- o Push the cancel button (shown in Fig. 5) to rub out any wrong word registrations.

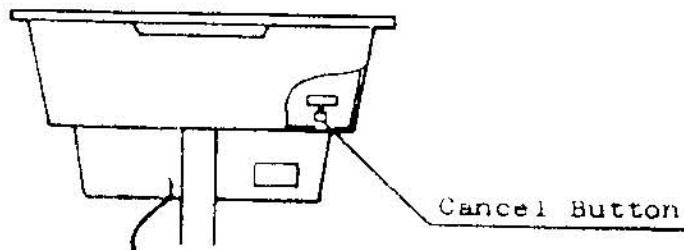

Fig. 5

6. HI-SCORE PLAYER'S NAME REGISTRATION

- (1) Alphabet (A-Z), (.), (RUB) and (END) will appear on the screen.
- (2) By pushing "LEFT" and "RIGHT" buttons, move cursor to any one character.
Pushing "DOWN" button register that character.
(See Fig. 6)

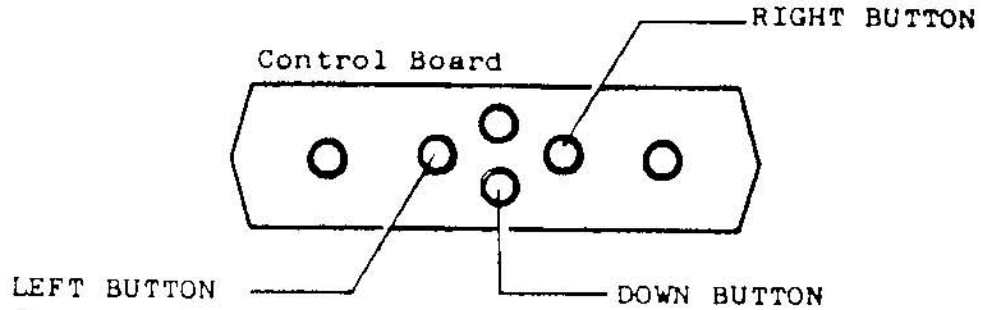

Fig. 6

- "RUB" ... To erase any wrongly registered characters.
- "END" ... When registration is completed, move cursor under "END" and push "DOWN" button.
- (3) Up to 10 letters can be registered, but the register will be automatically finished in the following cases:
 - o When more than 10 letters are registered.
 - o When "END" is registered.
 - o When player 1 or player 2 button is pushed.
 - o When 90 seconds passed.

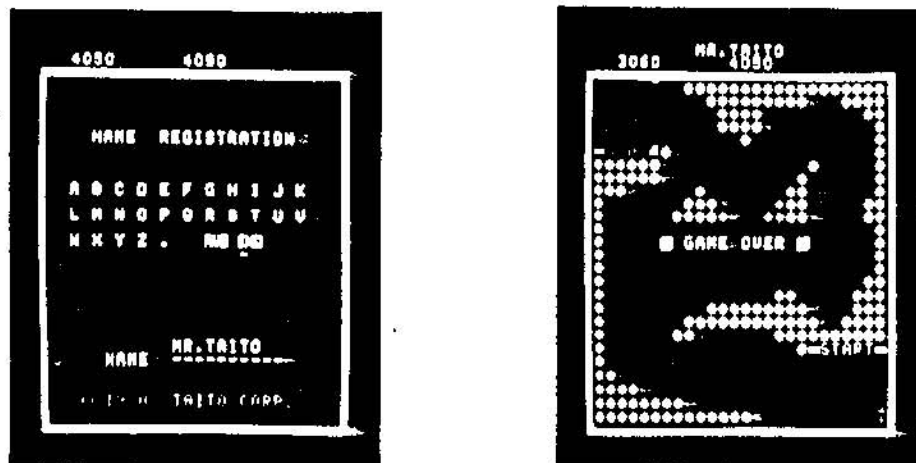

Fig. 7

7. Adjustments on Switching Regulator PC Board

(See Fig. 8)

Caution: The line voltages should be set within the limit.
Failure to do so may result in destruction of the IC's.

o To check the output voltage, measure them on the G-connector or the T-connector.

(See the attaching cable Block Diagram No. AAR00237.)

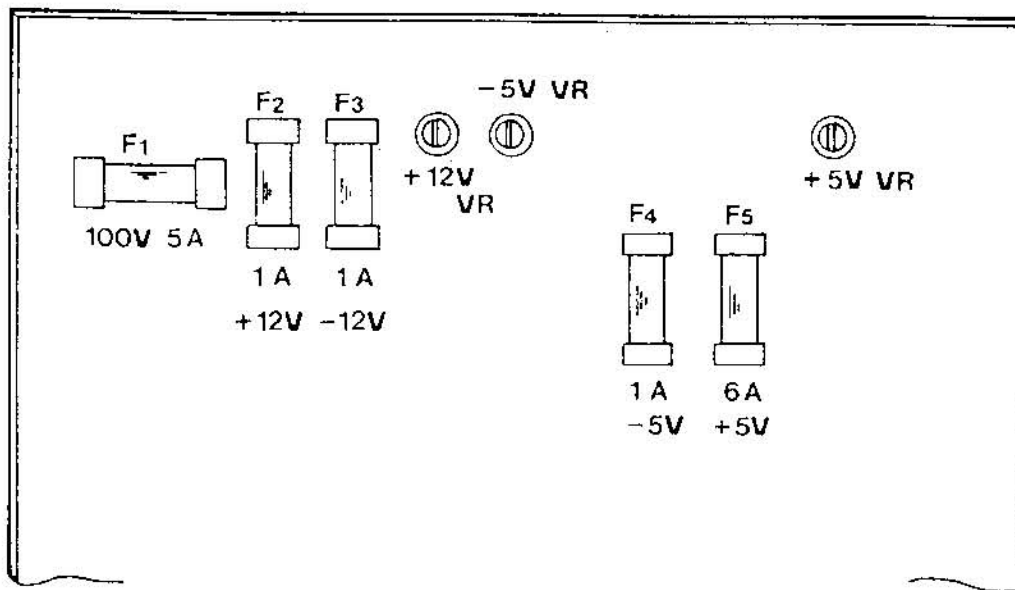

Fig. 8

- o +5V VR Pot for adjusting +5V DC line voltage
(Adjustment range: +4.5V to +5.5V DC)
Set approx. +5V.
- o -5V VR Pot for adjusting -5V DC line voltage
(Adjustable range: -5.5V to -4.5V DC)
Set approx. -5V.
(When the +5V line has no load, this -5V voltage is not present on the line.)
- o +12V VR Pot for adjusting +12V DC line voltage
(Adjustable range: +10.8V to +13.2V DC)
Set approx. +12V.

8. Adjustments on Game PCB (See Fig. 9 and Table 1-5)

As to the pots 1 - 4, to decrease the sounds, turn each pot as shown below.

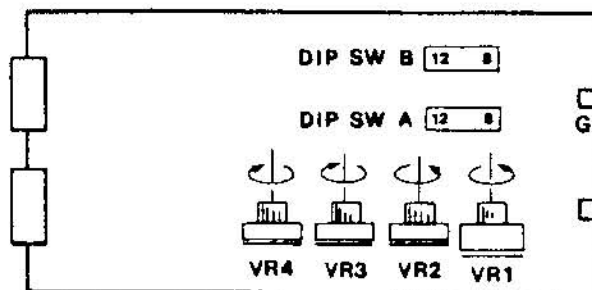

Fig. 9

- o VR1 ... Pot for adjusting the total sounds
- o VR2 ... Pot for adjusting the sounds when a balloon is broken by obstacles
- o VR3 ... Pot for adjusting the sounds and music produced when a balloon moves
- o VR4 ... Pot for adjusting the sounds when a balloon bursts

Adjustments on DIP Switch:

DIP Switch A :

- o SW1 ... Switch for checking. Normally, this switch should be set at "OFF" position.

SW 1	ON	RAM Check
	OFF	I/O Check

Table 1

- o SW2 ... Switch for rotating images on the screen
As this game is an upright version, this switch should be set at "OFF" position.

SW 2	ON	TT Version
	OFF	Upright

Table 2

- o SW3 and SW4 ... Switches for changing the number of balloons

	2	3	4	5
SW3	ON	OFF	ON	OFF
SW4	ON	ON	OFF	OFF

Table 3

These switches are preset for 4 balloons.

- o SW5 ... Switch for changing the points for extended play (One balloon is given for extended play.)

SW5	ON	5,000 pts.
	OFF	10,000 pts.

Table 4

This switch is preset at "OFF" position.

- o SW6, SW7 and SW8 .. Switches for changing play pricing

SW6	SW7	SW8	COIN(S)	PLAY(S)
ON	ON	ON	--	--
OFF	ON	ON	4	1
ON	OFF	ON	3	1
OFF	OFF	ON	2	1
ON	ON	OFF	1	1
OFF	ON	OFF	1	2
ON	OFF	OFF	1	3
OFF	OFF	OFF	1	4

Table 5

These switches are preset for 1 coin - 1 play.

DIP Switch B :

- o SW1 ... Switch for checking. When this switch is set at "ON" position, balloon will be not broken when hitting obstacles.
Normally, this switch should be set at "OFF" position.

- o SW2 - SW5 .. These switches are connected in the circuit, but not used for changing game functions.

- o SW6 - SW8 .. These switches are not used in this game.

Normally, DIP Switch B should be set at "OFF" position.

SWB All SWITCHES off

9. Adjustments on Color Video Monitor

(See Fig. 10)

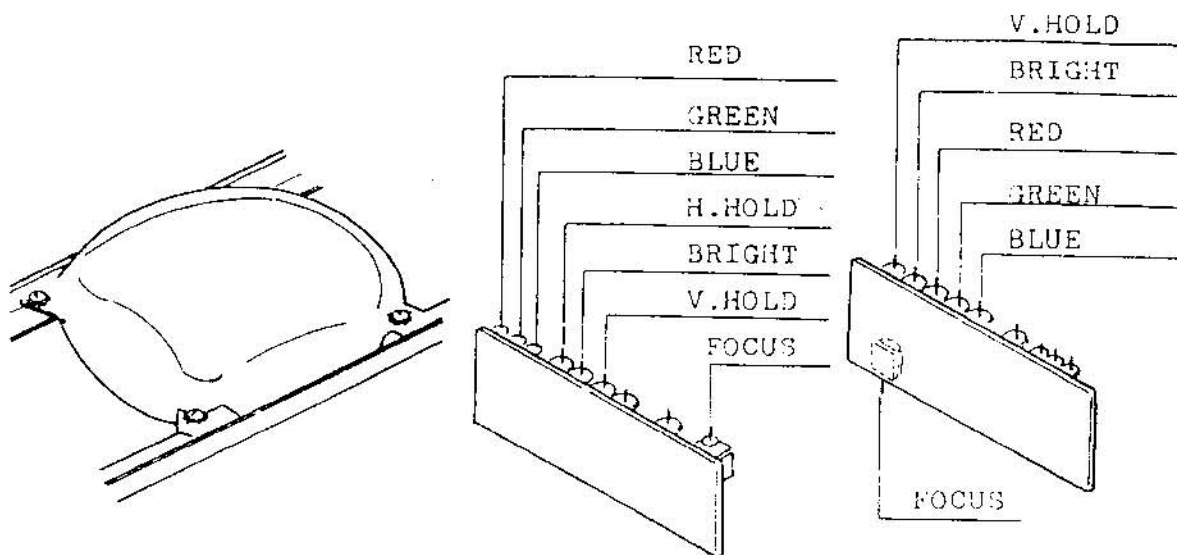

Fig. 10

The color video monitor is properly adjusted before shipping, however, if necessary, readjust as follows:

Caution: Careful attention should be required to adjust the horizontal hold and the vertical hold, since these adjustments are delicate.

o Horizontal Hold

Adjust the H.HOLD control if the picture is warped or broken into diagonal lines.

o Vertical Hold

Adjust the V.HOLD control if the picture rolls vertically across the screen.

o Screen Brightness

Adjust the BRIGHT control to keep the screen clear.

o FOCUS ... Screen Focus Control.

Color Control:

o RED ... Pot for adjusting red color

o GREEN ..Pot for adjusting green color

o BLUE ...Pot for adjusting blue color

Note: (1) Color aberration may occur depending on the setting condition of the machine. In that case, use a degussing device. Keep magnet away from the screen, otherwise, it may result in color aberration.

(2) The color video monitor of Taito "CRAZY BALLOON" is for exclusive use, therefore, it can not be replaced with that of other models.

10. Degaussing Switch

Color aberration may occur depending on the setting condition of the machine. In that case, use the degaussing switch. (Use this switch 10 minutes after used once.)

11. Service Switch

Use this service switch to increase the number of credits.

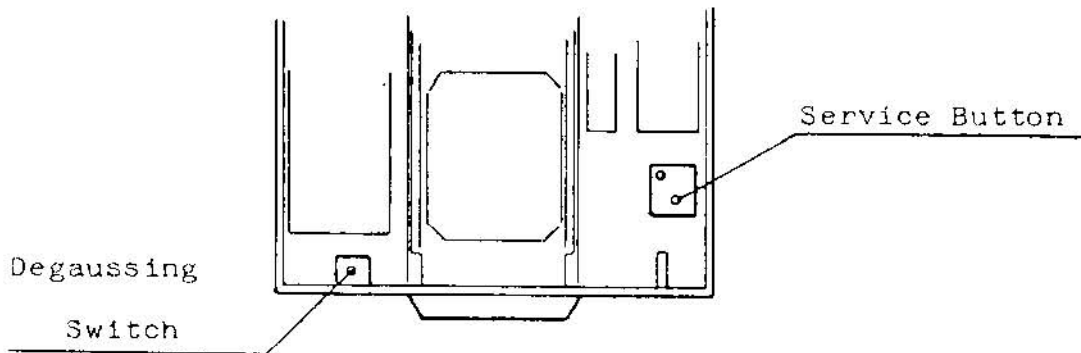
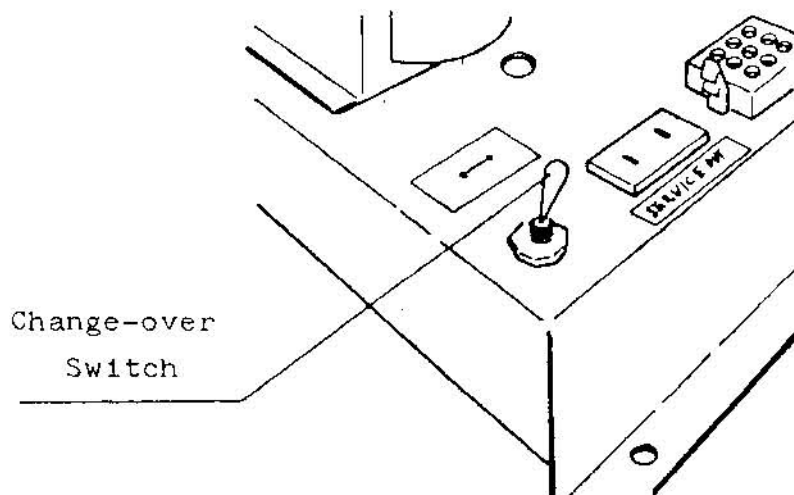

Fig. 11

12. Adjustments of Supply Voltage (See Fig. 12)

If the voltage of the power supply is low, the picture on the screen sometimes flickers. In that case, change the terminal of the power transformer in the cabinet. This adjustment is obtained by the use of the change-over switch.



13. Troubleshooting and Repair:

This video game mainly consists of the following four units.

- o Monitor Unit
- o Game P C Board Unit
- o Control Unit
- o Power Supply Unit

These units are connected by wiring cables. If any of the units is defective, the game will not normally function. In case of troubleshooting, therefore, the first thing you have to do is to predict what unit is defective. If you can predict that a unit might be defective, check the unit. But if the unit was found to be not defective, check the other related unit(s).

(1) Checking of Each Unit

Use an ohm-meter (with the accuracy of the 2nd class or so) and the cable block diagram(AAR00236 or AAR00237), and make certain the numbers of the connectors and the wiring colors are correct. Next, check each unit according to the method of checking (mentioned in the item 2.) There are two basic checking; continuity checking and voltage checking.

A) Continuity Checking

Each part and the PCB connector are connected by use of wiring cables and intermediate connectors. Check whether the current flows correctly through these circuits according to the following procedures.

- 1 Set the resistor-range of the ohm-meter at "X10" or "X100".
- 2 Put the lead of the meter on the conductive part of the connector and put the other lead of the meter on the terminal of the part to be measured to see whether the pointer indicates at "0" Ohm. If the pointer indicates at "0" Ohm, the continuity is all right.

(CONTINUTY CHECKING)

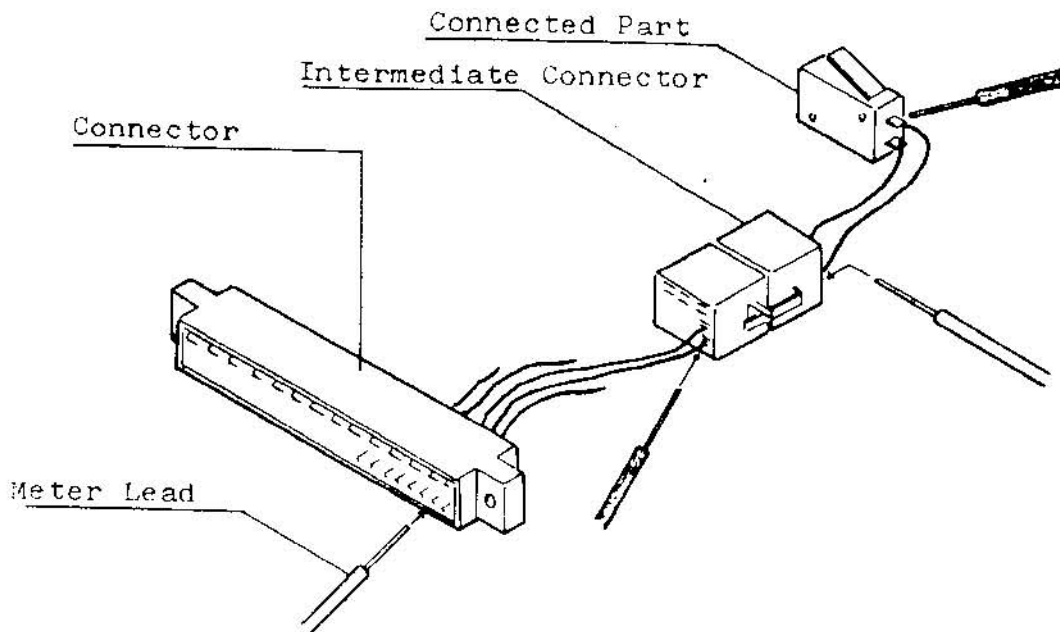

Fig. 13

B) Voltage Checking

1 Measurement of AC-Voltage

Set the ohm-meter at an AC-voltage range. In this case, select the range slightly larger than the measured voltage. Put the meter lead on the conductive part of the connector to see whether each line voltage is correctly appears.

The voltage should be nearly the same value when measured at the beginning of the wiring or at the end of the wiring.

2 Measurement of DC-Voltage

Set the ohm-meter at a DC-voltage range. In this case, select the range slightly larger than the measured voltage. Put the minus lead (black lead) of the meter on the GND line (black wire, zero volt) and put the other lead (red lead) on the point to be measured.

The voltage should be nearly the same value when measured at the beginning of the wiring or at the end of the wiring.

(2) Method of Checking

1 Checking on Control Unit and Coin Unit

Check whether the switches, the speakers, the coin counters, and the lockout coils correctly function. If these parts not normally function, check as follows:

A Check on Switches

The following switches are used in this game, the coin switch, the 1-player and the 2-player start switches, the control button switches, and the service switch.

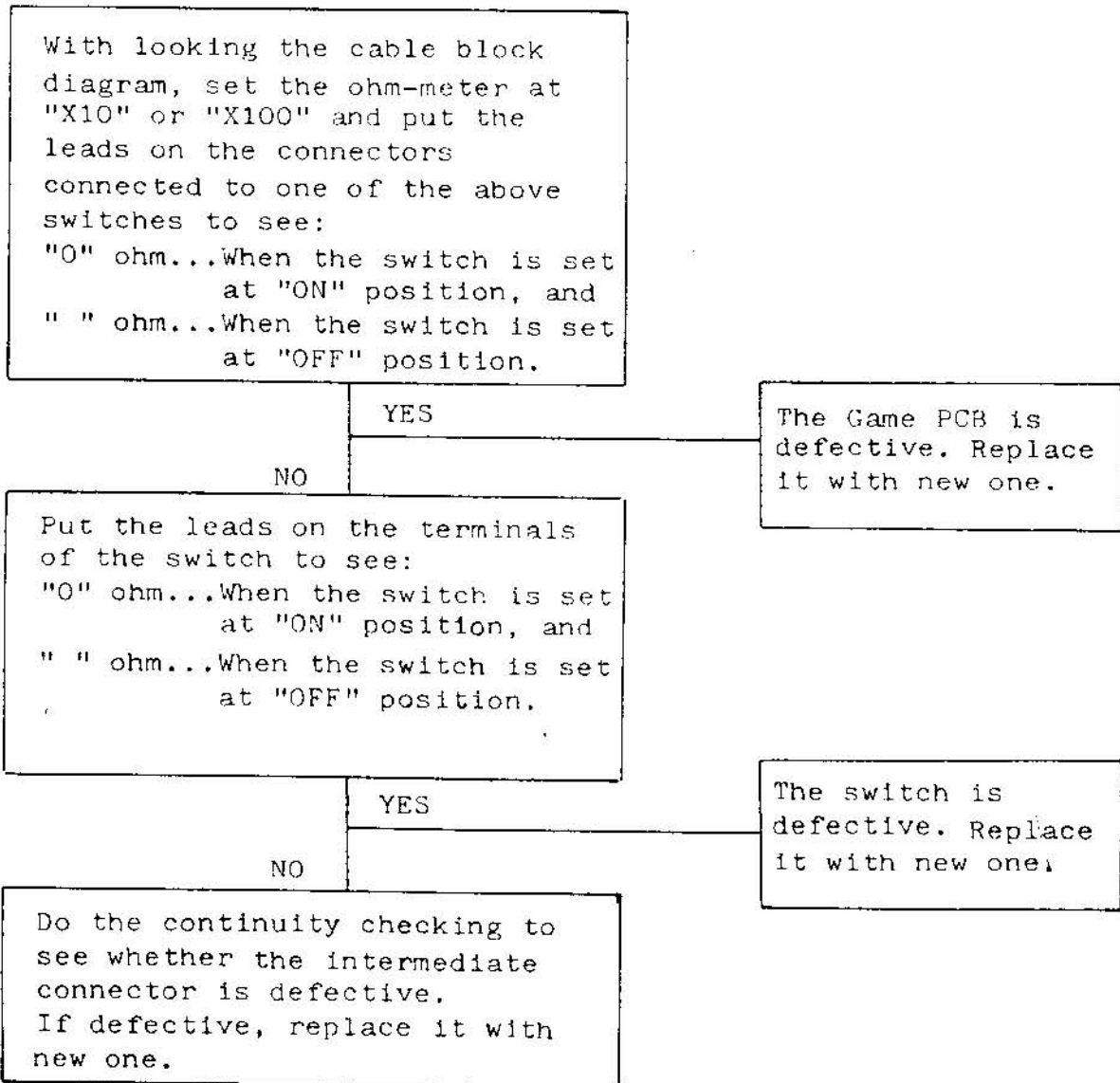

B Check on Speaker

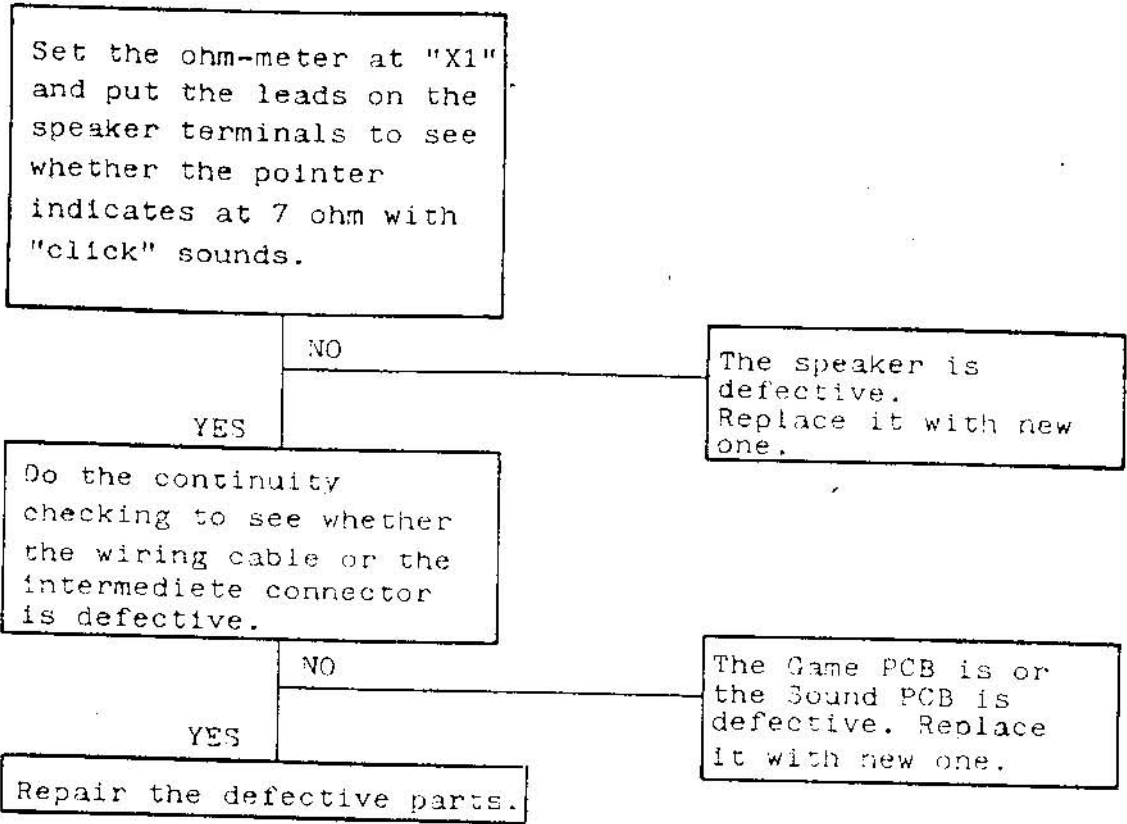

C Check on Coin Meter and Lockout Coil

If the Coin Meter or the Lockout Coil does not function, check as follows:

Coin Meter:

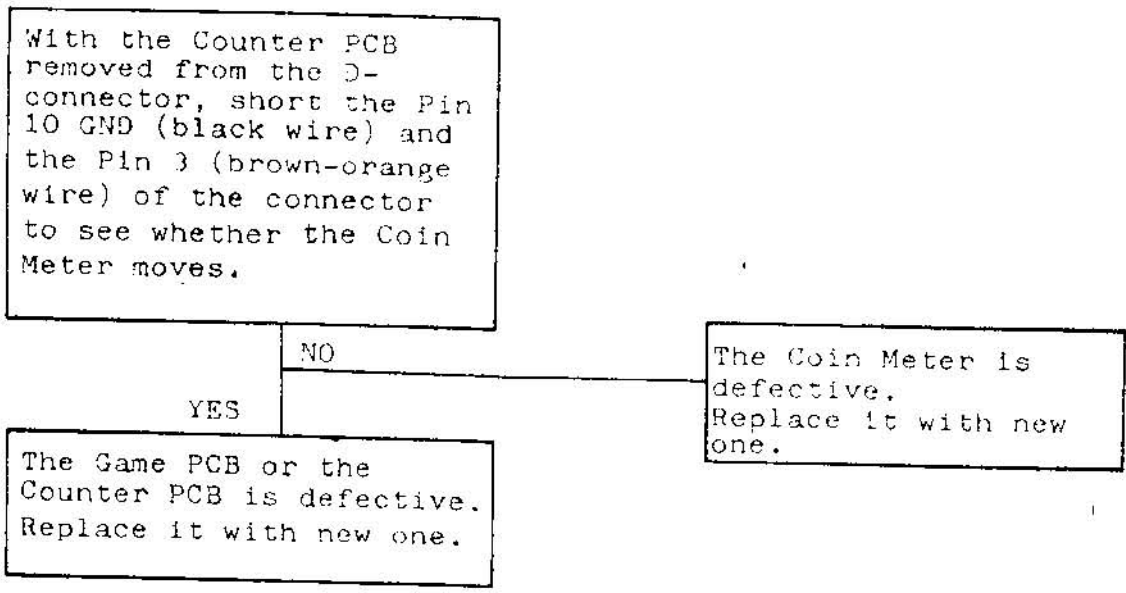

Lockout Coil: (Table type machine only.)

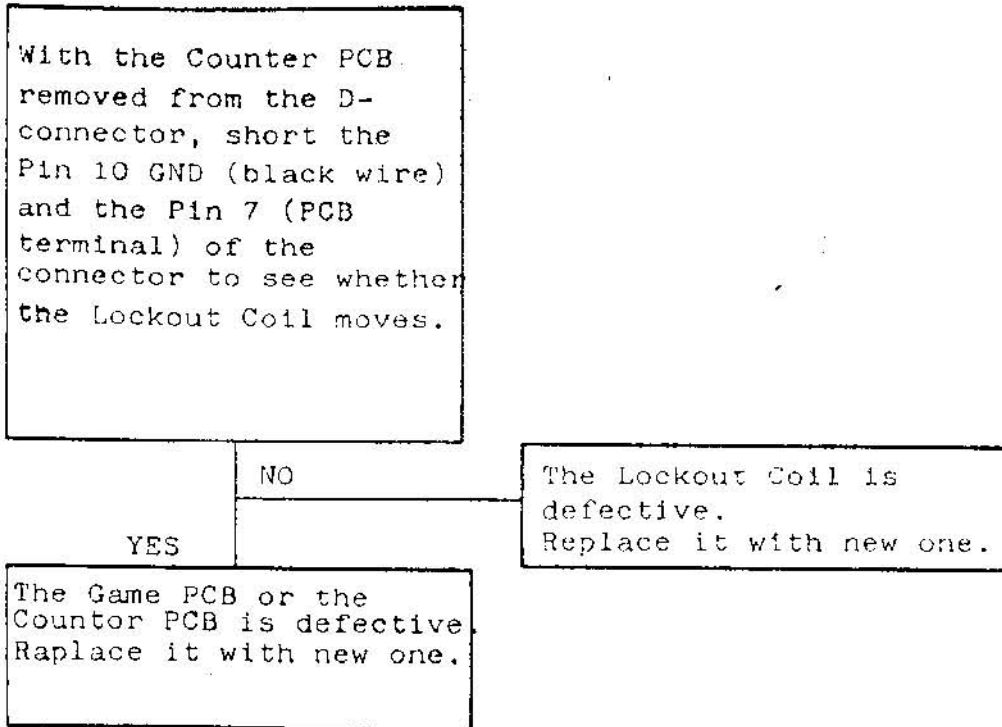

14. Game over

- ① The characters "INSERT COIN" will flash and, except for the center part, the field will be filled with thorns (Fig. 14).

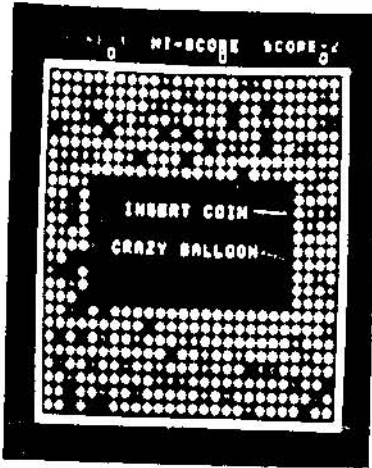

White flashing indication

Yellow

Fig. 14

- ② The LEVEL-1 display will appear and the characters "INSERT COIN" at the top of the center part of the screen will flash. The computer controlled balloon will move through the field from the START position to the goal (Fig. 15).

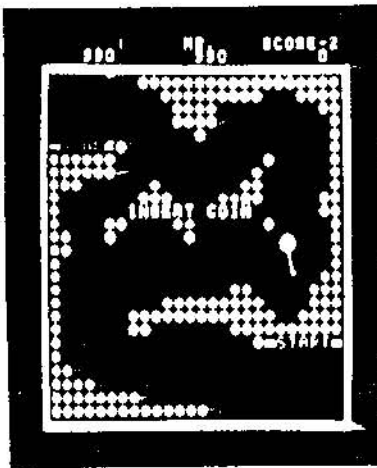

- ③ When the balloon enters the goal, the display of "1" will reappear.

Fig. 15

- ④ A white face will appear at the left hand side of the screen in the LEVEL-1 pattern. The computer controlled balloon will move to the top right hand side of the screen while being blown by the wind. After a lapse of several seconds a second face will appear at the right hand side of the screen and blow the balloon about until it bursts (Fig. 16).

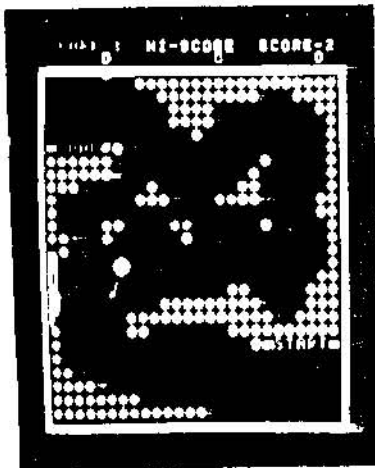

The above steps ① to ④ will be repeated continuously by way of demonstration until a coin is inserted.

Fig. 16

15. Coin insertion (Fig. 17)

- o When a coin is inserted the demonstration will be interrupted and the following display will appear. This display will remain until either the 1-player or 2-player start button is pressed.

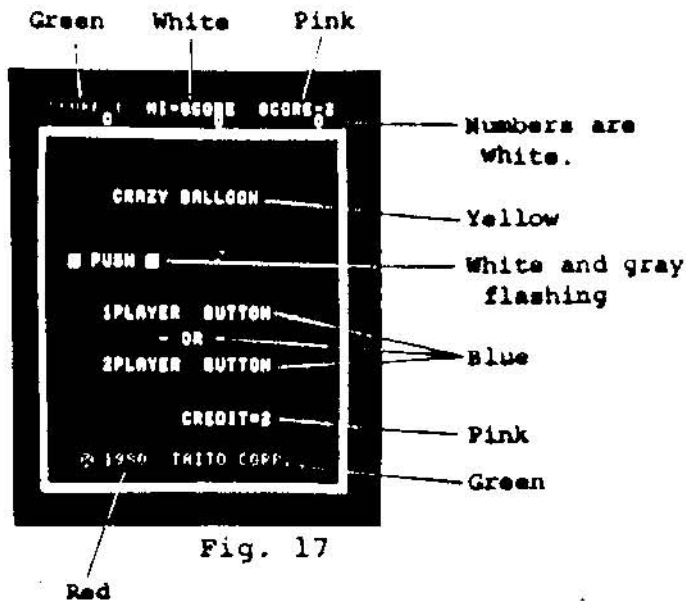

Fig. 17

- o OR 2-PLAYER BUTTON
This display will appear when two or more credits are obtained.

- o Up until this point in time the score for the previous game will be retained.
- o When either the 1-player or 2-player button is pressed, the "LET'S ATTACK" display will appear.

16. LET'S ATTACK display (interval display before commencement of play) [Figs. 18 and 19].

- o At the commencement of play or when the balloon enters the goal, the No. 1 display will appear and, in the latter case, triumphant tones will sound to indicate success. If the balloon fails to enter the goal, the No. 2 display will appear and appropriate tones will sound to indicate failure.

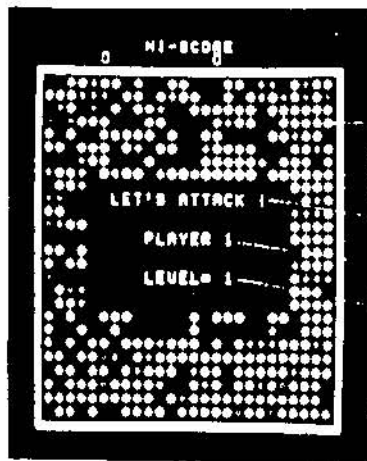

No. 1

The screen will become filled at random with blue, green and pink thorns.

Yellow

Blue (next player's number)

White (number of next level)

Fig. 18

No. 2

Thorns do not appear.

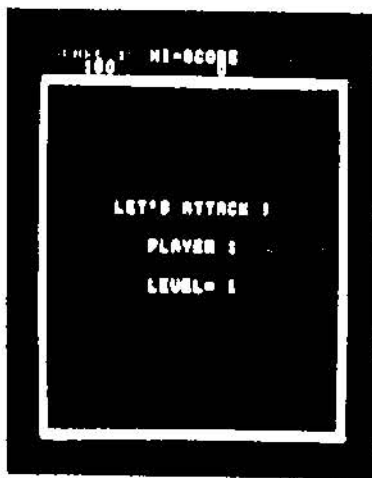

Fig. 19

17. NAME REGISTRATION (Fig. 20)

- o Move the cursor underneath the characters to be registered using the LEFT and RIGHT control buttons, and register the characters using the DOWN button. Register 10 characters in 1 minute 30 seconds.

The next display will come up when

1. END is pressed.
 2. More than 10 characters are registered.
 3. The 1P or 2P button was pressed.
 4. 1 minute 30 seconds has elapsed.
- o If nothing was registered, the characters "HI-STORE" will be displayed.

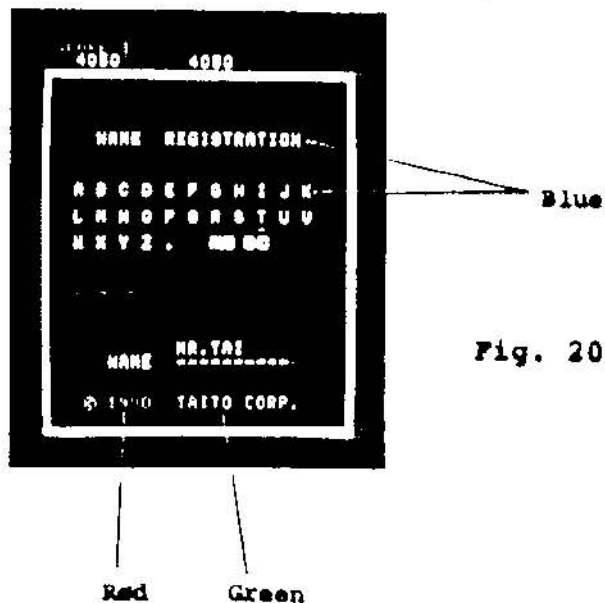

Fig. 20

18. Description of background display

There are 3 types of basic patterns, each of which has the following features:

- ① The thorns will be partially removed to permit the balloon to move more freely.
- ② Some of thorns will move start to move.
- ③ All of the thorns will start to move.
- ④ The white face is displayed from the beginning and waits for the balloon to approach it.

Including other variations there are a total of 16 different patterns.

LEVEL-1

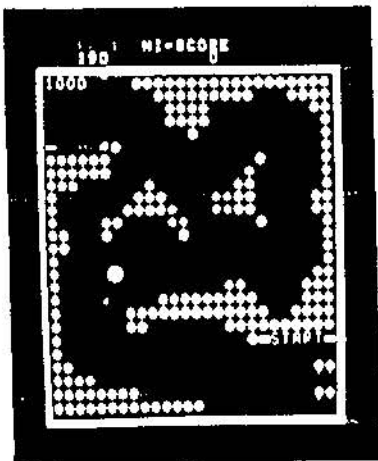

The balloon will be red and the pattern will be stationary.

LEVEL-2

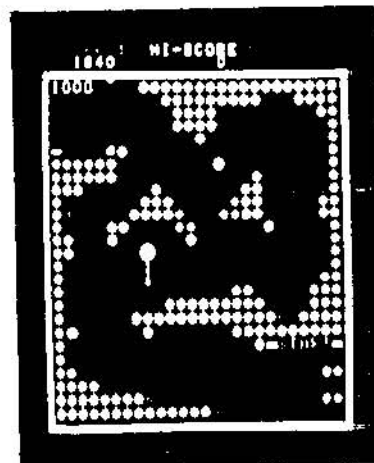

Two thorns will start moving.
One thorn will disappear.

LEVEL-3

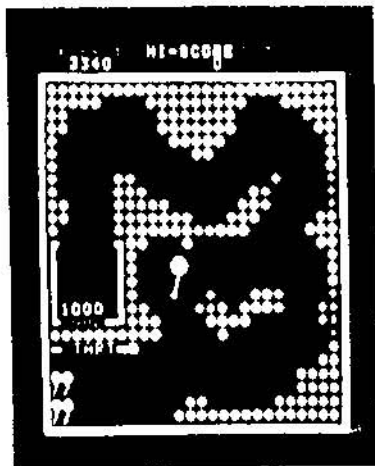

The balloon will be pink and the pattern will be stationary.

LEVEL-4

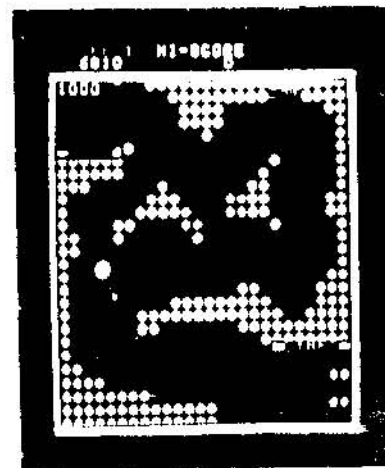

The pattern is the same as that of LEVEL-1, however all of the thorns will move up and down and left and right.

LEVEL-5

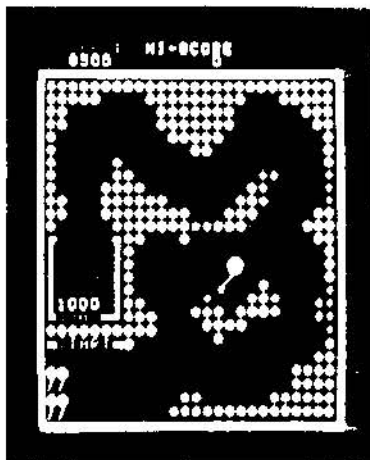

The pattern is the same as that of LEVEL-3, however the number of thorns will increase slightly, making the game more difficult.

The thorns will move up and down. When the balloon moves underneath the thorns, the thorns will move downwards, and when the balloon moves at the left side of the thorns, the thorns will commence moving upwards.

LEVEL-6

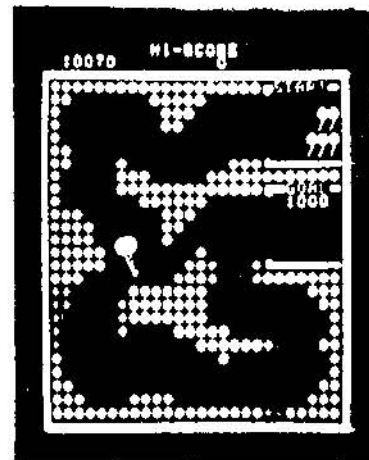

The balloon will be yellow and the display will be stationary.

LEVEL-7

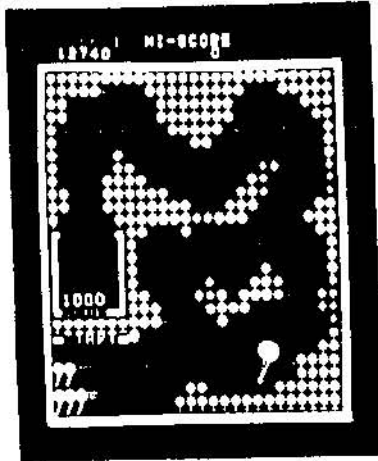

The pattern will be the same as that of LEVEL-5. All of the thorns will move up and down and left and right.

LEVEL-8

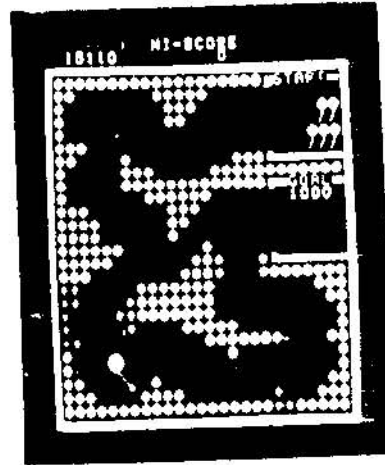

The pattern is the same as that of LEVEL-6, however the number of thorns will increase slightly. The display will be stationary.

LEVEL-9

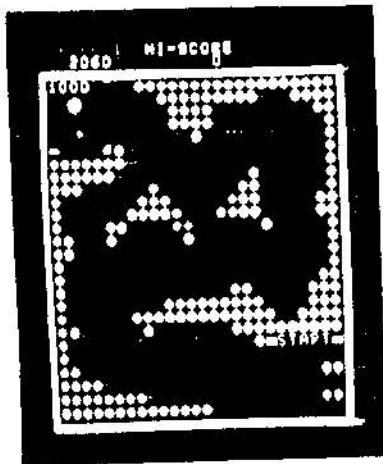

Exactly the same as LEVEL-1.

LEVEL-10

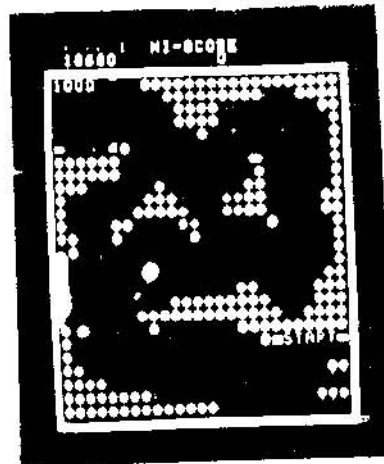

The pattern and also the movement of the thorns will be the same as that of LEVEL-2, however the face will appear on the screen from the beginning and will blow the balloon when it approaches.

LEVEL-11

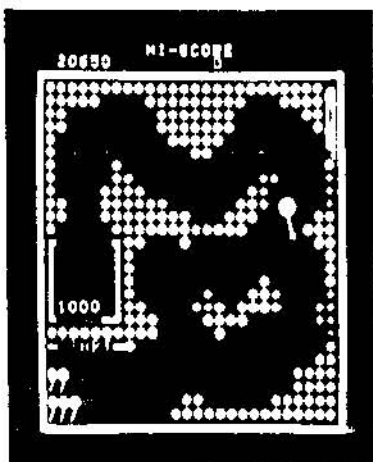

The pattern is the same as that of LEVEL-3 and the display will be stationary. The face will appear on the screen from the beginning.

LEVEL-12

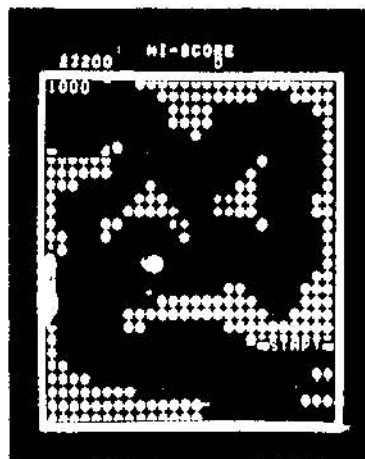

The pattern and movement of the display will be the same as that of LEVEL-4 and all the thorns will move.

The face will appear on the screen from the beginning.

LEVEL-13

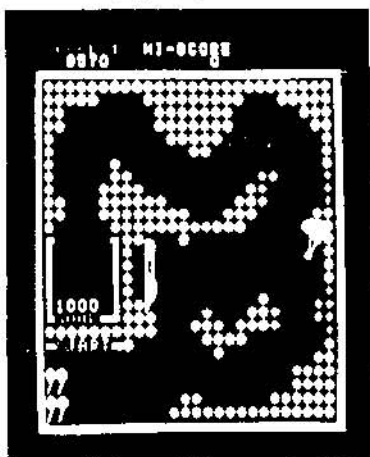

The pattern is the same as that of LEVEL-5 and the face will appear on the screen from the beginning.

The thorns will move up and down.

LEVEL-14

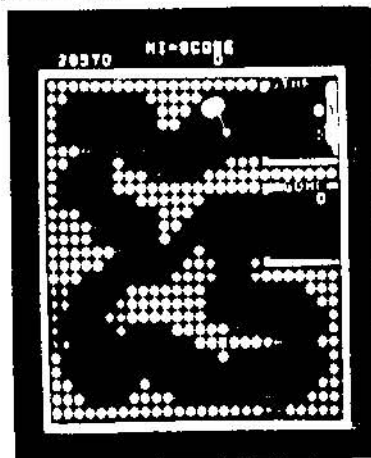

The pattern will be the same as that of LEVEL-8 and the display will be stationary.

The face will appear immediately behind the starting position of the balloon and will start blowing as soon as the balloon starts to move.

LEVEL-15

LEVEL-16

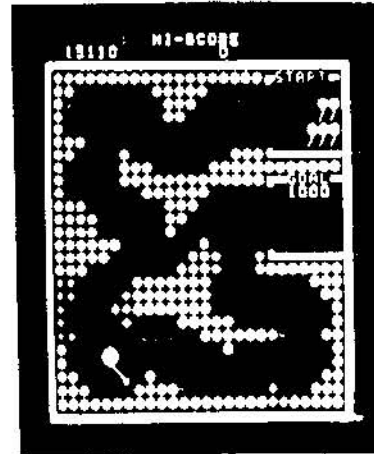
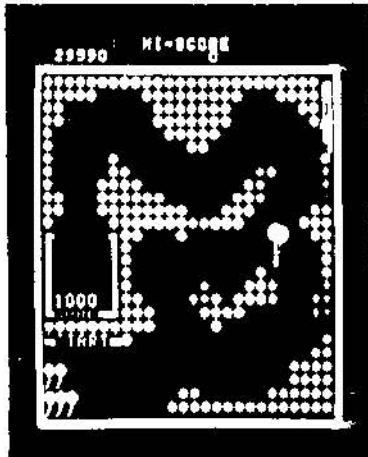

The pattern and movement of the display are the same as that of LEVEL-7 and all of the thorns will move up and down and left and right.

The face will appear from the beginning.

The pattern is the same as that of LEVEL-8. All of the thorns will move up and down and left and right.

19. Pattern movement and score-up

- o For LEVEL-17 and higher, the displays of LEVEL-1 to LEVEL-16 will appear repeatedly. Also, for LEVEL-17 and higher, the swaying of the balloon will become faster and for LEVEL-33 or above it will become still faster.
- o When the balloon strikes a thorn and bursts, the thorn will disappear.

o The balloon will not burst if it strikes the boundary at the start position, however once it has gone past the boundary, causing the score to increase by 10 points, it will burst when it touches the boundary at the start position. Once the balloon has entered the goal, it will not burst no matter what it touches.

o A bonus will be displayed at the goal position and will gradually be reduced as time passes. The bonus remaining when the balloon enters the goal will be added to the score.

The bonus will be 1000 points for the first 20 seconds and will be reduced by 20 points for every subsequent 5 seconds.

o If the balloon is in the same position for 8.5 seconds or more, the yellow face will appear and blow the balloon in an attempt to burst it. (at the start of play this interval will be 17 seconds). Also, if the balloon does not enter the goal within 2 minutes, the face will likewise appear and try to burst the balloon.

o When the balloon moves towards the goal by a distance equal to that of one thorn, the score will increase in accordance with the color of the thorn.

- * Blue 10 points
- * Green 200 points
- * Pink 300 points
- * Yellow 500 points

The score will only increase, however, when the field is divided into vertical and horizontal blocks in accordance with the path of the balloon and the balloon moves through the blocks towards the goal. Consequently, the score will not increase if the balloon moves in the reverse direction through the blocks or cuts across the blocks. Furthermore, once the balloon has passed through a certain point, causing the score to increase, the score will not increase any more if the balloon passes through the same point a second time.

20. Color differentiation of basic patterns (Figs. 21, 22 and 23)

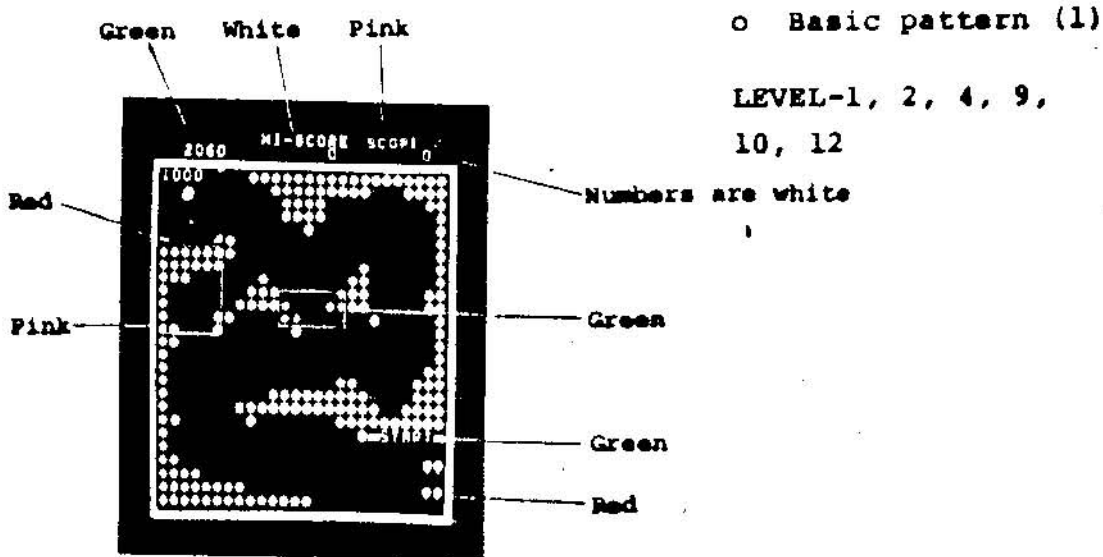

Fig. 21

o Basic pattern (2)

LEVEL-3, 5, 7, 11, 13, 15

o Basic pattern (3)

LEVEL-6, 8, 14, 16

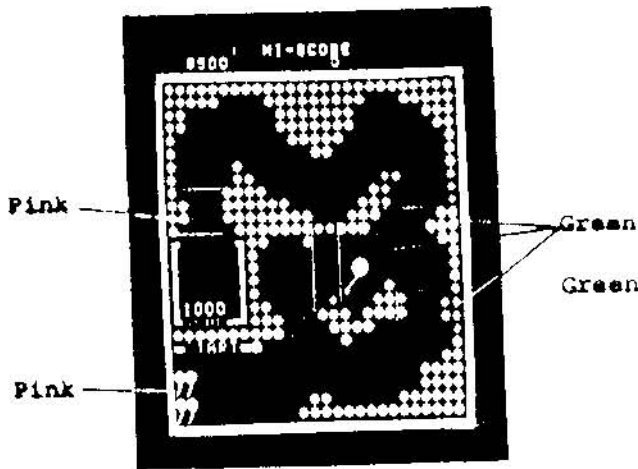

FIG. 22

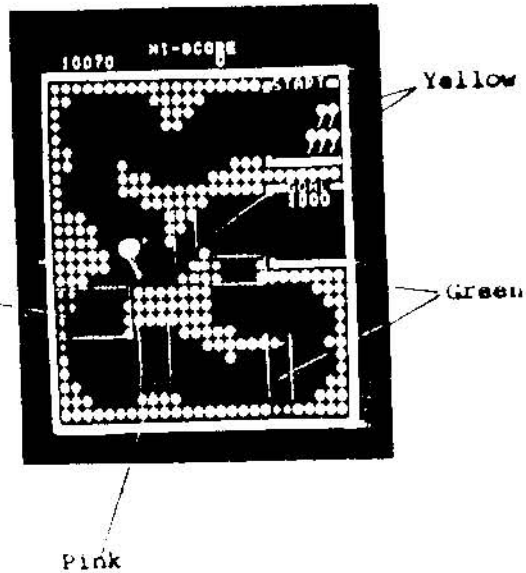

FIG. 23

21. How to use CRAZY BALLOON CHECK ROM

(CHECK ROM is CL090011.)

The check ROM is used by allocating the check ROM ADDRESS between 0000 and 07FF (by replacing CL01). The check ROM can perform I.O check, SOUND check and RAM check. To change over from I.O check to RAM check, use the DIP SWA (SW1) at the top of the game board.

DIP SWA (SW1)

ON	OFF
RAM check	I.O & SOUND check

A faulty RAM indication which appears as a result of a RAM check will be displayed on the monitor as a number between 1 and 5.

<u>Number</u>	<u>Meaning</u>
1	10E(2114)
2	11E(2114)
3	9F(2114)
4	10F(2114)
5	8F(2114)

* I.O check pattern (will be displayed on the TV screen.)

DIP SW

A- 1 2 3 4 5 6 7 8

B- 1 2 3 4 5

PUSH SW

1P- U D L R

2P- U D L R

Up Down

NR <input type="checkbox"/>	SV <input type="checkbox"/>	TL <input type="checkbox"/>	1P <input type="checkbox"/>	2P <input type="checkbox"/>	CN <input type="checkbox"/>
Name reset sw	Service sw	Tilt sw	1P select sw	2P select sw	Coin sw

OUT PUT

MUSIC
 CAUT
 BREATH
 EXPL
 LAUGH
 C-MTR
 LOCK
 V-INV

When the DIP SW and PUSH SW are ON, the marks disappear. During a SOUND check, the marks will successively shift and produce the respective tones. (This shifting action will be repeated.)

22. Test points

..... A signal having a period of 400 nS and 50% duty must always be applied.

When $L = 0.45$ V or greater, the voltage "H" must be at least $V_{cc} - 0.6$ V.

INT Must remain at "H" during RAM check.

During I.O check or game, a signal having a period of 1/60 sec which falls to "L" and then rises to "H" after several tens of μ seconds must be applied.

The rise of this signal must be synchronized with the rise of "VBL".

In this way, an interrupt will appear at the CPU when the TV screen goes into a BLANKING CONDITION.

RESET Shall be "H" level under normal conditions.

This signal shall become "H" when either the CPU goes into a runaway condition or the POWER-RESET does not function, thus preventing a deadlock.

It will become an "L" reset signal after a maximum of 4 seconds, and after a further 4 seconds will return to "H" to apply reset.

MVID Brightness signal to TV.

This signal is independent of the balloon pattern which is made separately. It must vary in units of 200 ns.

If noise appears on this signal, the balloon may hit a thorn in an unlikely place or stripes may appear on the screen.

STNC TV synchronizing signal

Horizontal synch signal: 15.36 KHz

Vertical synch signal: 60 Hz

* To technicians who repair printed circuit boards (P.C.D.)

1. Have a clear understanding of the content of the fault.

It is basically necessary, for only for a P.C.B. but also for any piece of equipment, to be clear as to what is wrong. Establish whether there is no image at all on the screen, no sound being emitted or a particular operation cannot be performed, etc.

2. Establishing faulty part

Once the content of the fault is clearly established, it is then necessary to pinpoint the location of the fault. The basic method of doing this is to gradually narrow the range of possible fault points. For example, if there is no explosion sound, first check whether or not explosion sound trigger signal is being emitted.

(2F, 74LS273 Pin (9)) If it is being emitted, there is a fault in the subsequent sound generator circuit. If it is not being emitted, there is a fault in the I.C. (2F, 74LS273) which generates the trigger signal.

If there are two or more printed circuit boards, try changing over the CPU board and game board. By comparing the respective conditions of the machine, it is possible using this method to determine which board is faulty.

Refer to the check flow on the subsequent pages when checking a picture, sound or operation fault. A synchroscope (at least 20 MH) should be used to check printed circuit boards.

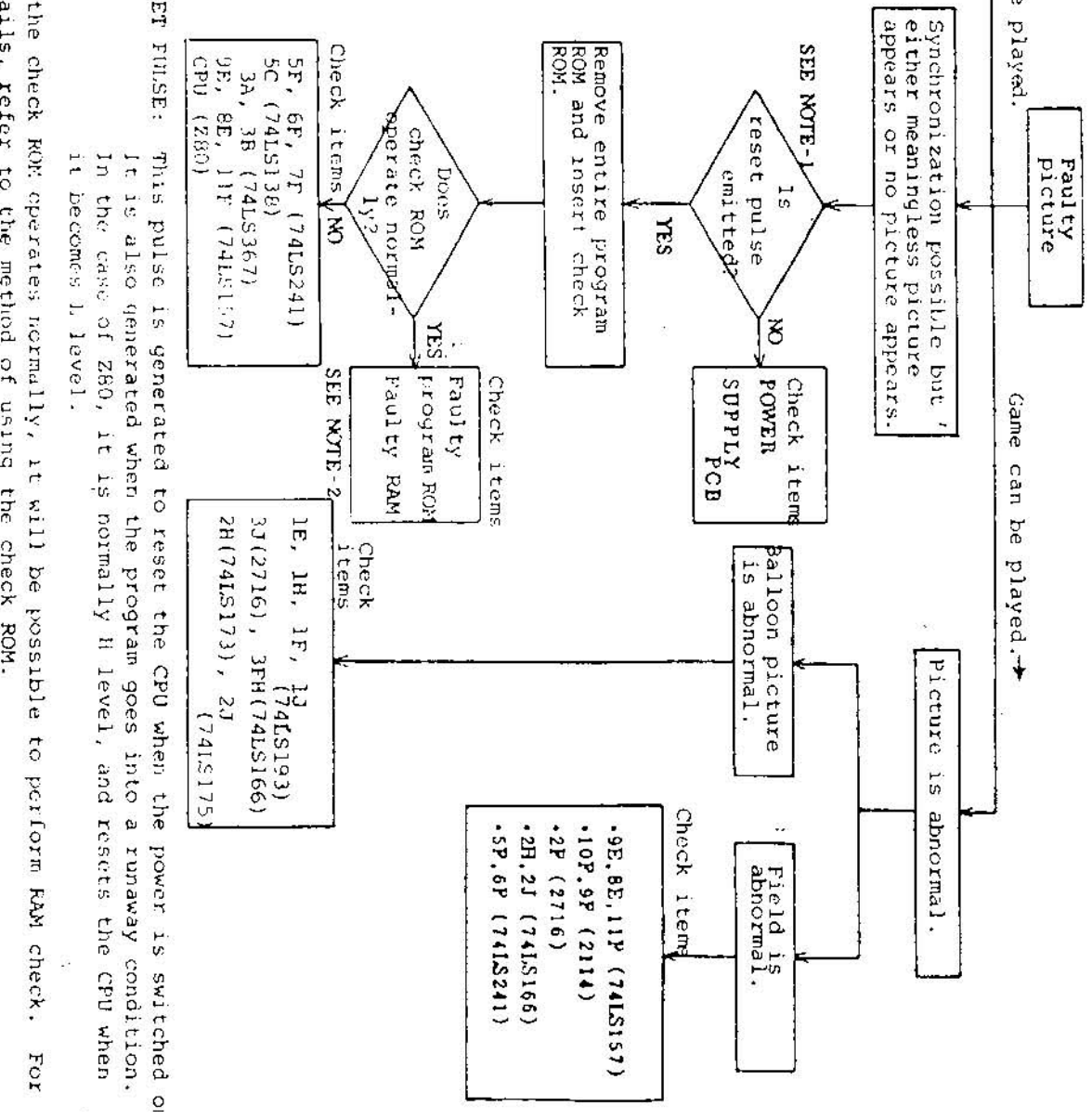
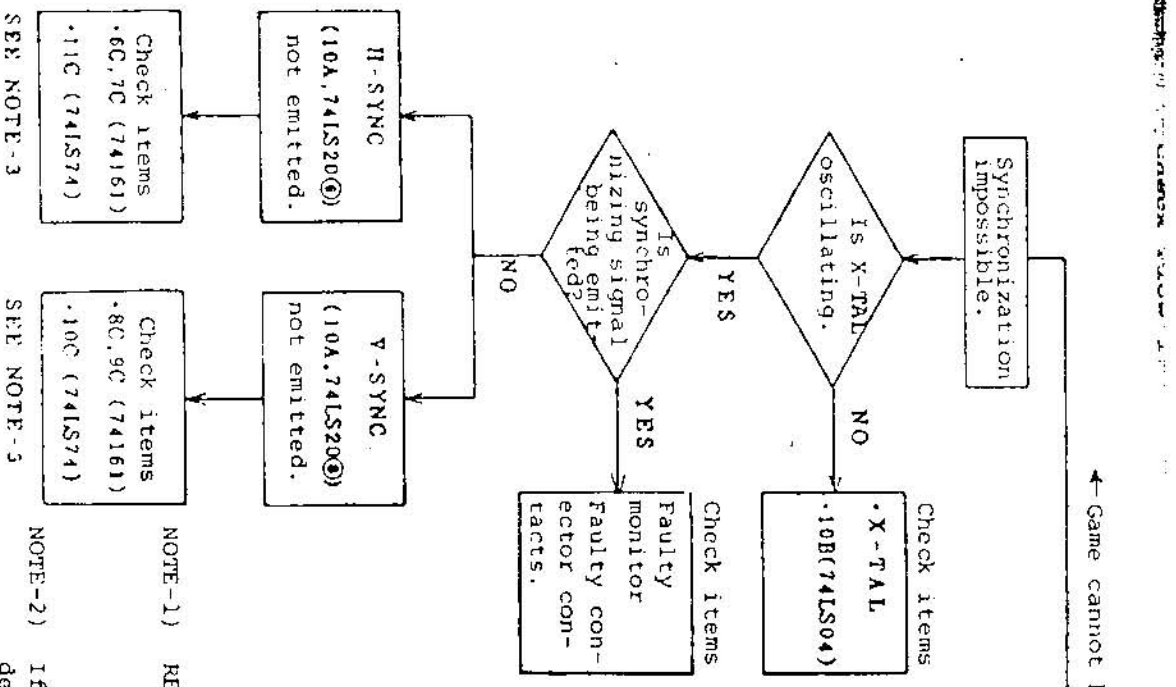

NOTE-1) RESET PULSE: This pulse is generated to reset the CPU when the power is switched on. It is also generated when the program goes into a runaway condition. In the case of Z80, it is normally H level, and resets the CPU when it becomes L level.

NOTE-2) If the check ROM operates normally, it will be possible to perform RAM check. For details, refer to the method of using the check ROM.

NOTE-3) Refer to the master clock timing table.

Check Flow 2

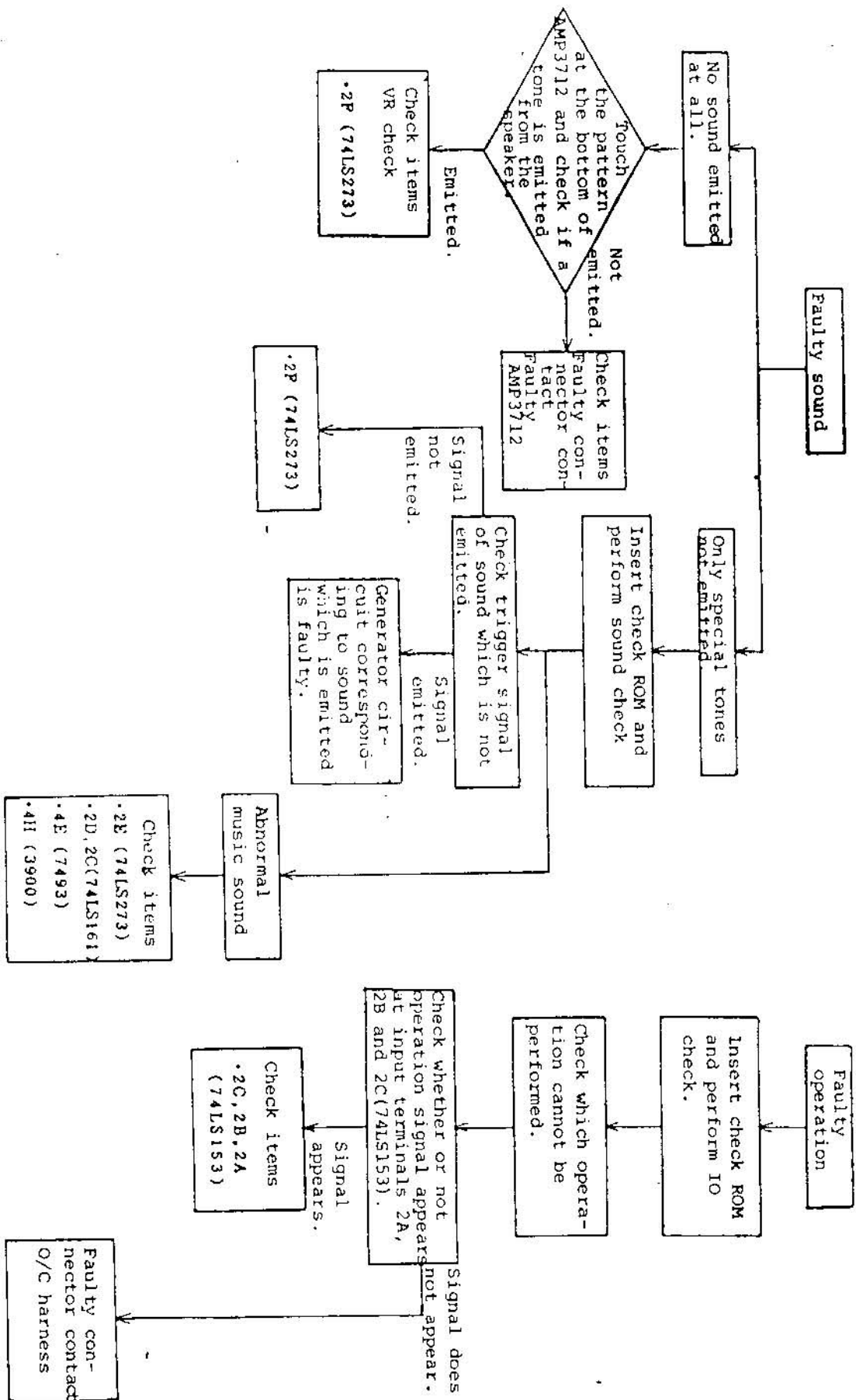

GAME BLOCK DIAGRAM

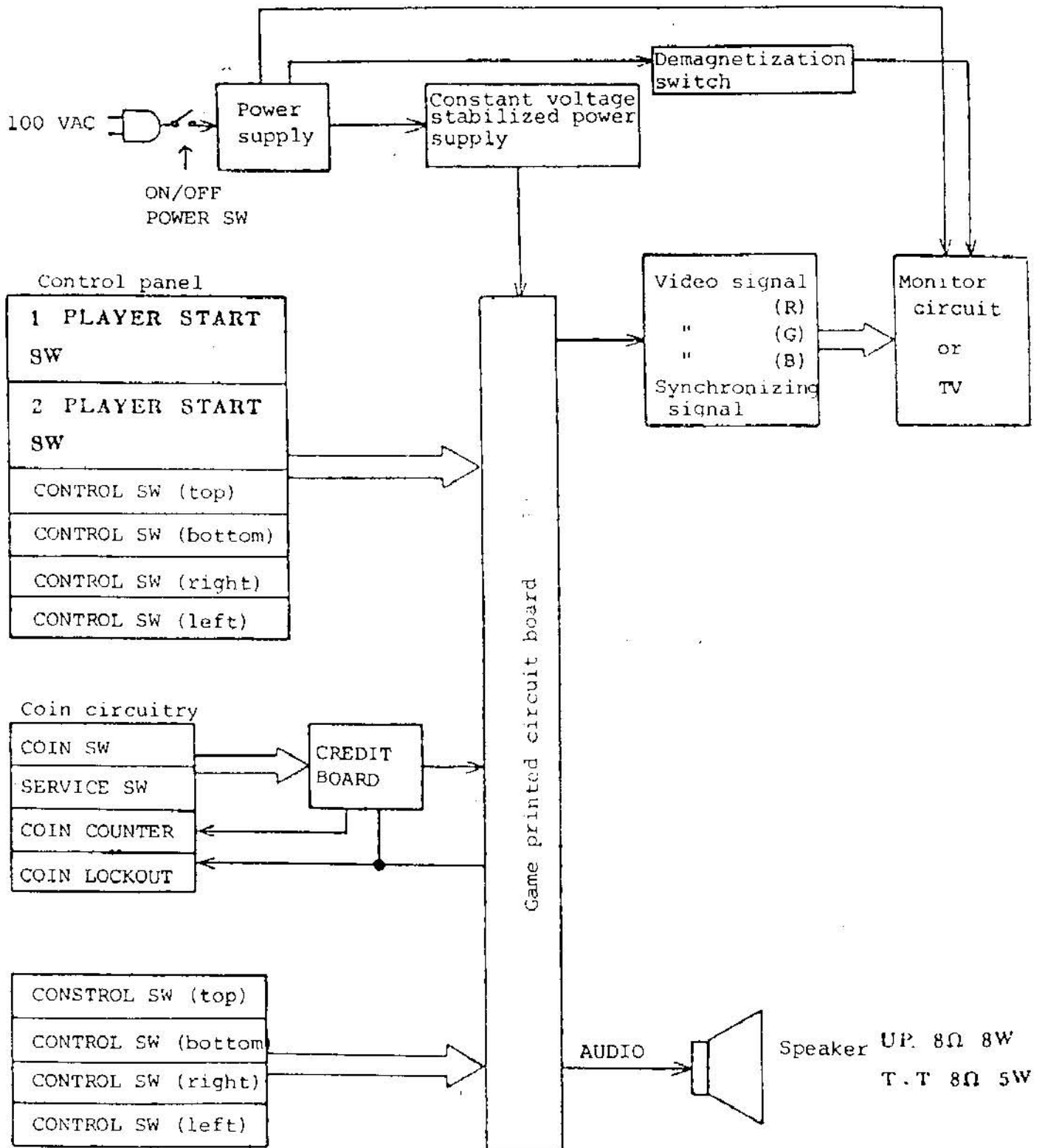

2-player control panel
(Table type machine only)

CABINET ASS'Y

SEE PAGE 44

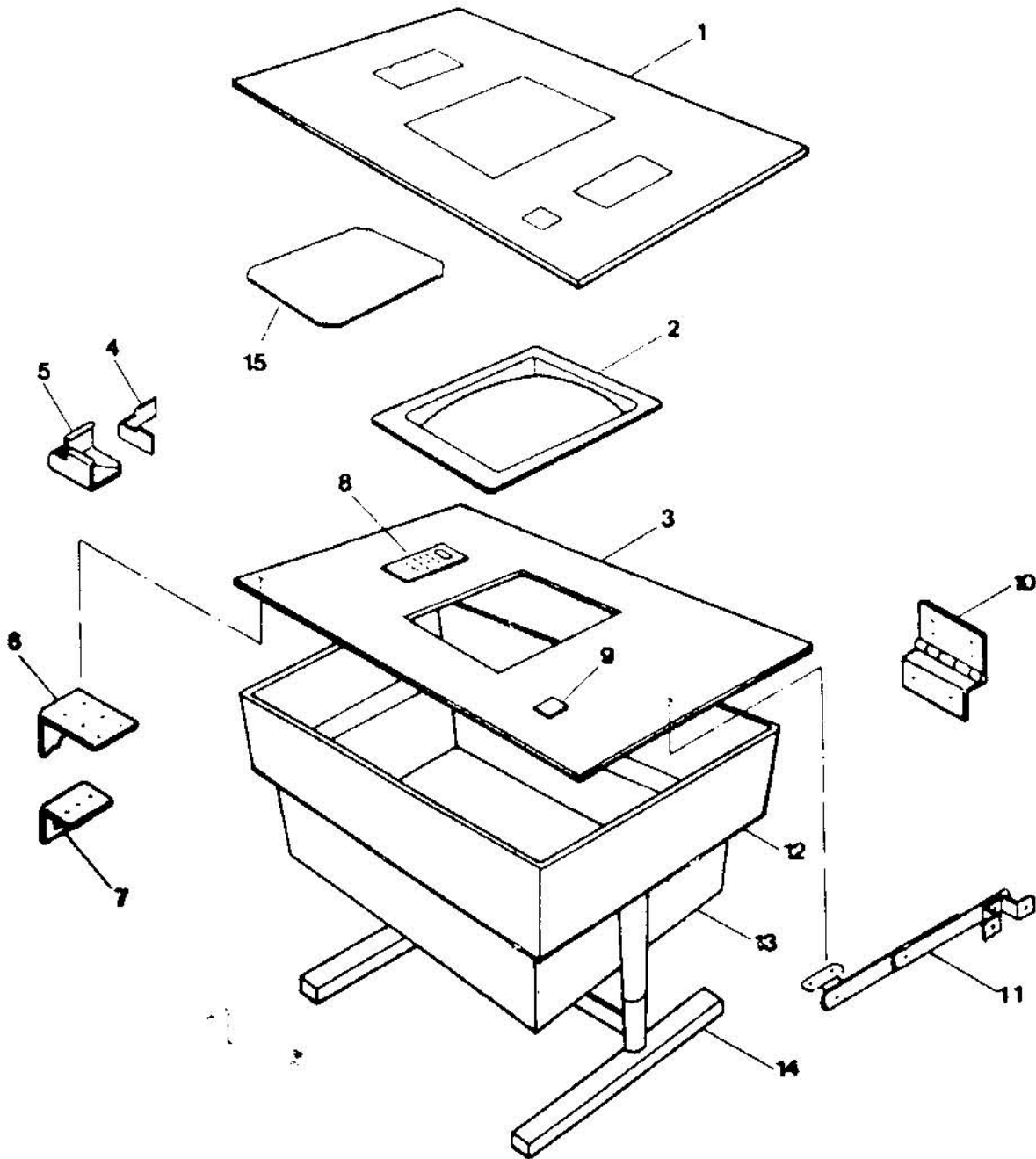

CONTROL PANEL ASS'Y

SEE PAGES 44,45

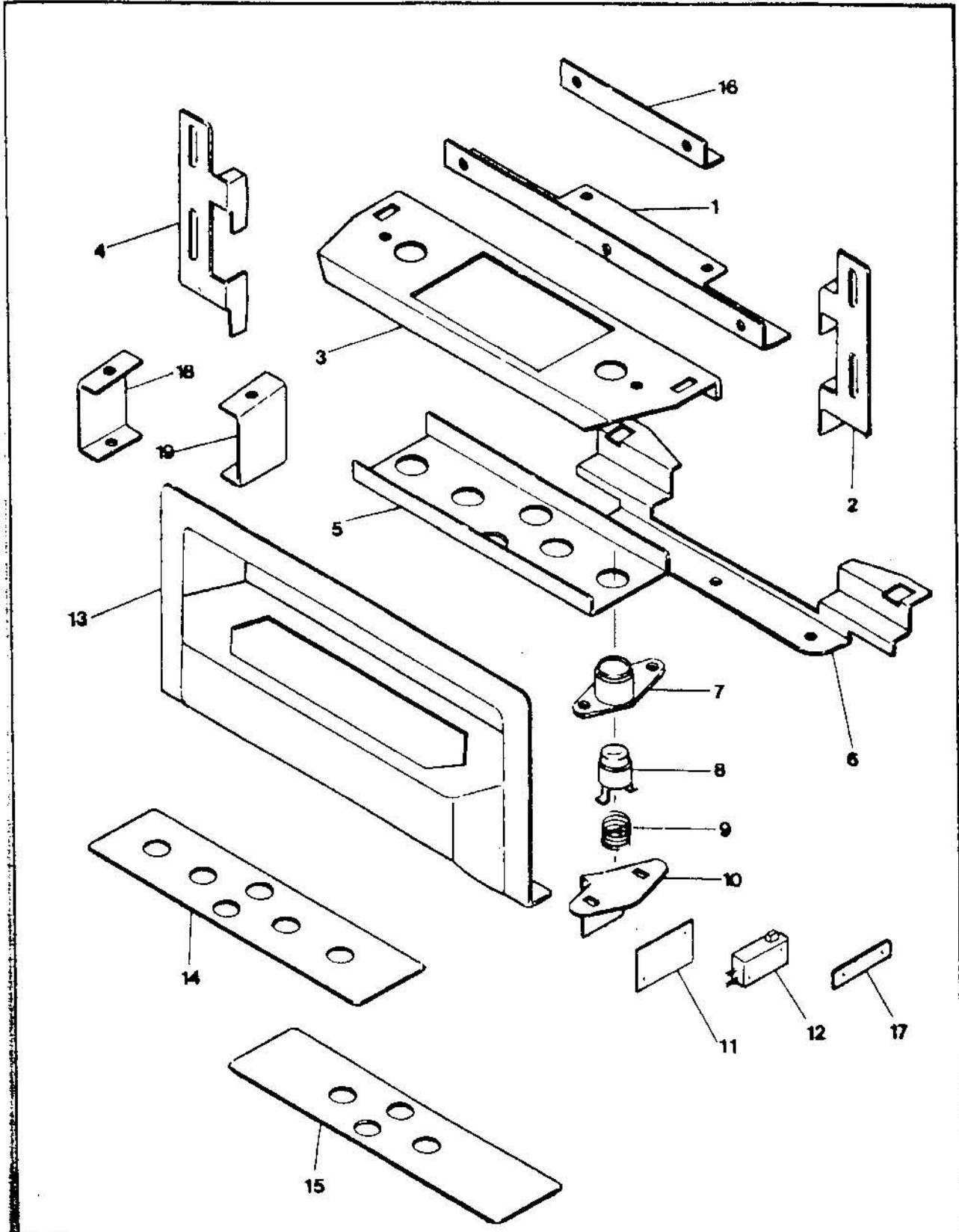

VIDEO AND CABINET ASS'Y

SEE PAGES 45,46

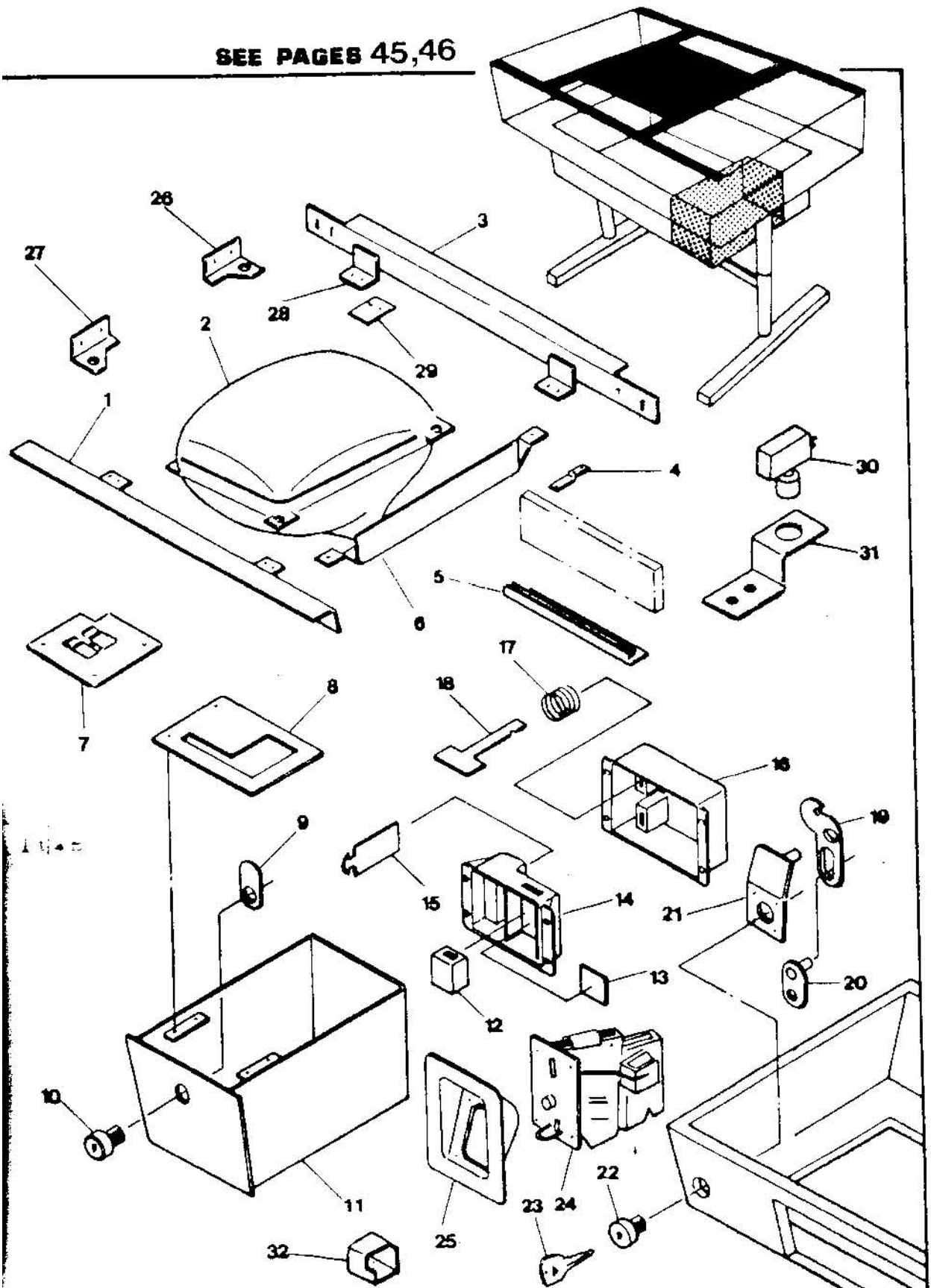

PRINTED BOARD AND REGULATOR ASS'Y

SEE PAGES 46,47

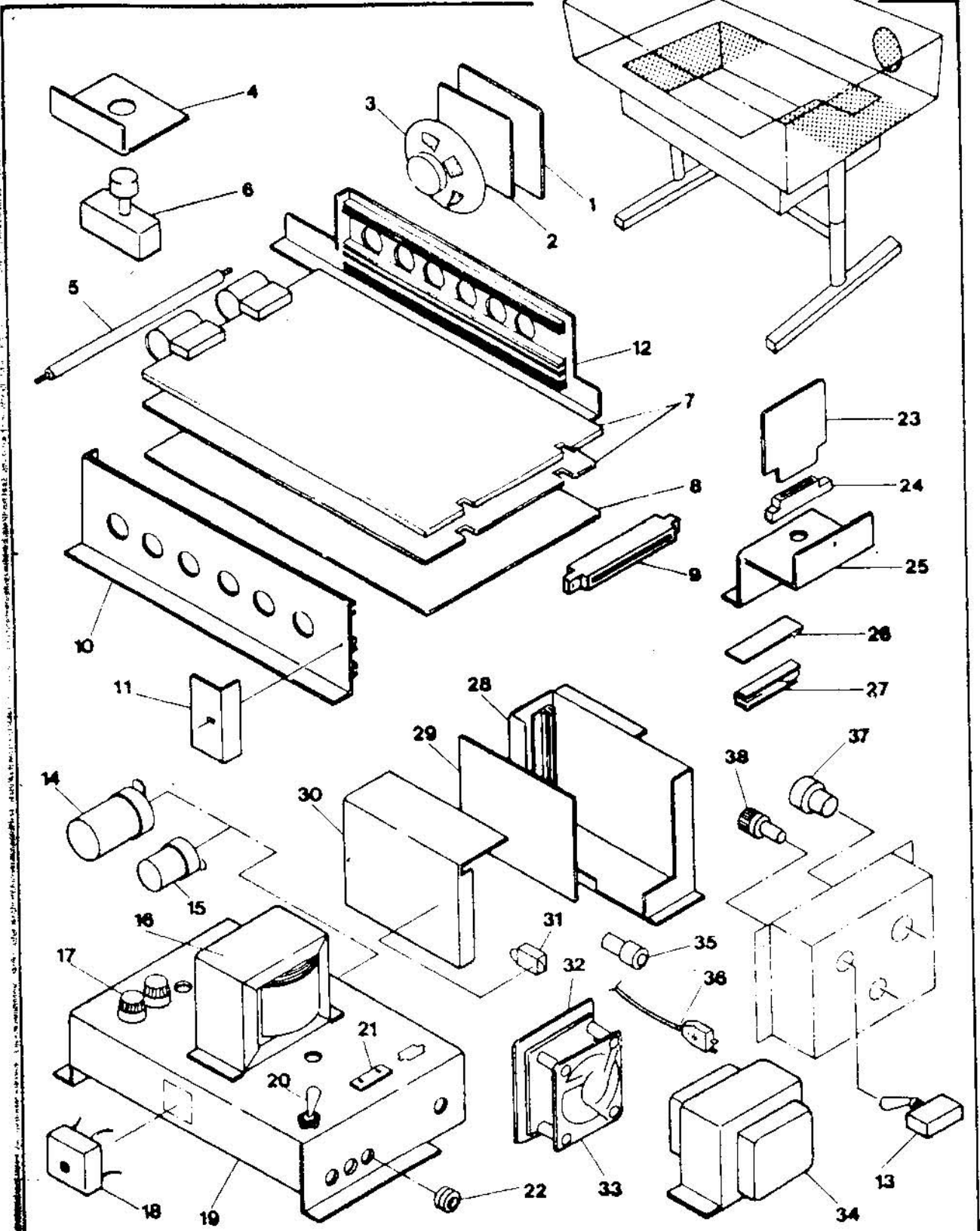

CABINET ASS'Y

Item	Part #	Description
1	LAO90007	Table Top Glass
2	AAO19570	Video mask
3	LAO10001	Top Board
4	AAO19545	Glass Bumper
5	AAO13593	Corner Bracket
6	AAO13605	Lock Bracket
7	AAO13606	Hook
8	CLO70011	Instruction Card
	CLO70012	High Score Card
9	AAO29521	Coin Sticker
10	TWO60001	Hing Assy
11	AAO16553	Hing Assy
12	CVO10006	Table Box
13	CVO30024	Bottom Box
14	AAO16556	Table Leg
15	LAO90008	Color Plate
16	LAO50001	Mask Support Spring

CONTROL PANEL ASSY

Item	Part #	Description
1	CLO30004	Control Bracket (B)
2	CLO30005	Control Lock (A)
3	CLO30001	Control Base
4	CLO30006	Control Lock (B)
5	CLO30007	Switch Base
6	CLO30002	Control Support (A)
7	AAO19574	Push Button Housing White
	AAO19572	Push Button Housing Red
10	AAO19573	Push Button White
14	AAO19571	Push Button Red

Item	Part #	Description
9	CLO50001	Button Spring
10	CLO30008	Push Switch Bracket
11	AAO19504	Insulator V-Type
12	AAO52577	Micro Switch VL-11
13	CLO90009	Control Panel
14	CLO70007	Control Plate (A)
15	CLO70008	Control Plate (B)
16	CLO80003	Control Bracket (A)
17	CLO30011	Tap Plate
18	CLO30009	Control Support (B)
19	CLO30010	Control Support (C)

VIDEO AND CABINET ASSY

Item	Part #	Description
1	LAO30005	Support Bracket (A)
2	AAM10103	Video 14inch Color
3	LAO30006	Support Bracket (B)
4	CVO30028	Video Circuit Board Support
5	TVO90009	Guide Rail
6	LAO30001	Video Bracket
7	AAO13620	Coin Chute (C)
8	CVO30003	Guide Plate
9	AAO13511	Lock Plate
10	AAO16501	Lock & Key
11	CVO30002	Cash Box
12	AAO51717	Counter ME-5
13	AAO18558	Packing
14	AAO19559	Counter Box
15	AAO12619	Contact Plate (A)
16	AAO19558	Contact Plate Guide
17	WTO50002	Spring
18	AAO13618	Contact Plate (A)

Item	Part #	Description
19	AAO13604	Lock Lever
20	AAO13603	Lock Plate
21	AAO13602	Lock Lever Pin
22	AAO16561	Service Lock #8000
23	AAO16562	Service Key #8000
24		Rejector
25	AAO19552	Coin Entry Cover
26	LAO30003	Video Support Bracket (B)
27	LAO30002	Video Support Bracket (A)
28	LAO30004	Video Bracket Base
29	AAO19575	Insulation Sheet
30	AAO52511	Push Button Switch VAQ-4R
31	PVO30001	Push Switch Bracket
32	AAO13624	Coin Return Cup

PRINTED BOARD REGULATOR ASSY

Item	Part #	Description
1	AAT71001	Speaker 8Ω 5W 12cm
2	WNO90007	Net
3	WNO30015	Punching Metal
4	AAO13575	Push Switch Bracket
5	TUO20001	Shaft
6	AAO52511	Push Button Switch VAQ-4R
7	CLK00001	Main P.C Board Ass'y
8	CVO30022	Shield Plate
9	AAO55949	AMPLEAF Connector 18P
10	WTO90008	P.C Board Guide (B)
11	CVO30023	Stop Bracket
12	AAO19547	P.C Board Guide
13	AAO52501	Toggle Switch S-301
14	AAT41175	Capacitor 35LASN 4700
15	AAT41172	Capacitor 35LASN 1000

MASTER CLOCK GENERATOR

$\overline{A1}$

$\overline{A2}$

1H HORIZONTAL Q_A (1)

2H Q_B (2)

4H Q_C (3)

8H Q_D (4)

16H Q_E (5)

32H Q_F (6)

64H Q_G (7)

128H Q_H (8)

10A ⑥ H. SYNC

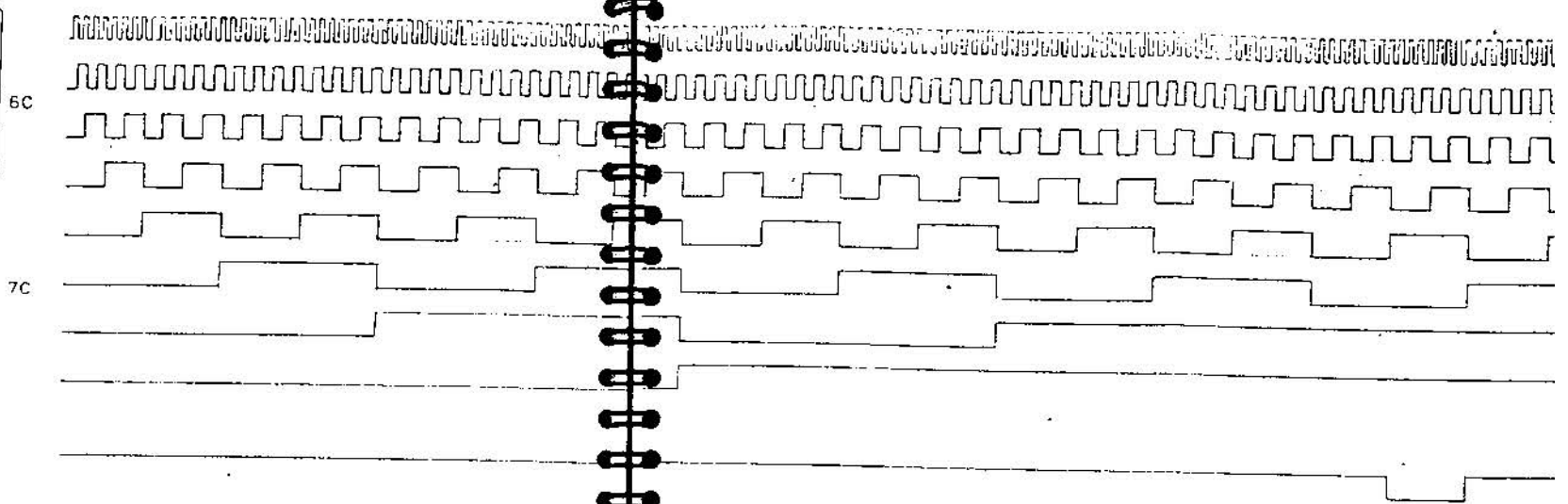

1V VERTICAL Q_A (1)

2V Q_B (2)

4V Q_C (3)

8V Q_D (4)

16V Q_E (5)

32V Q_F (6)

64V Q_G (7)

128V Q_H (8)

10A ⑧ V. SYNC

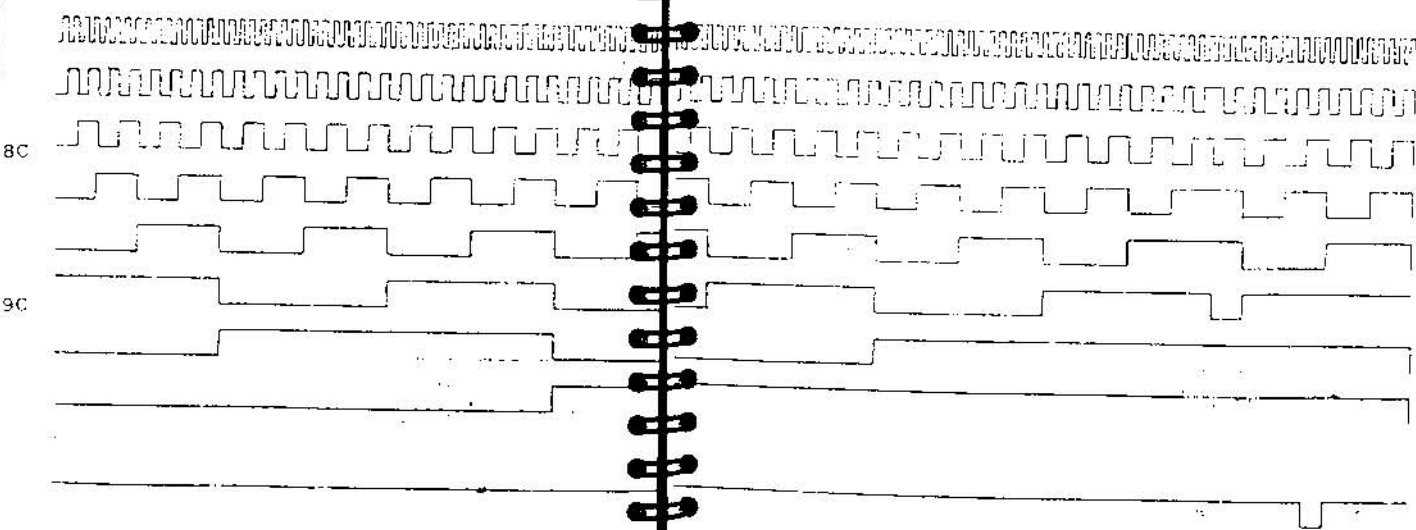

B1

B2

NO.	DESCRIPTION	UNIT
1	PC 3092	CUSTOM IC
2	PC 3093	CUSTOM IC
3	PC 3094	CUSTOM IC

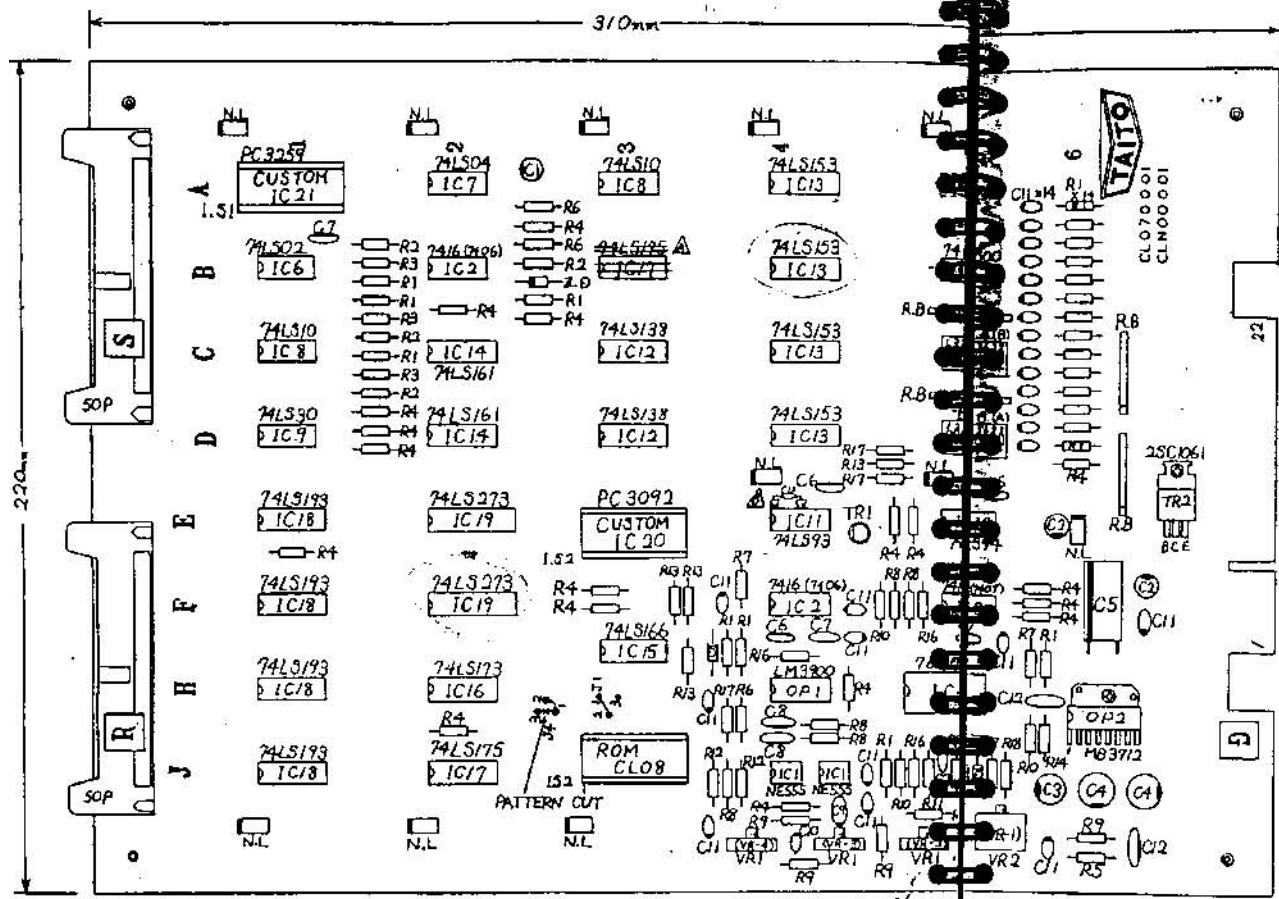

NOTE 11 DIP SWITCH

A) ADDRESS 5D (A)

NO	ON-OFF	DESCRIPTION
1	ON	RAM CHECK
1	OFF	I/O CHECK
2	ON	TABLE TYPE
2	OFF	UP RIGHT TYPE
3	ON	BALLOON NUMBERS
4	OFF	5000 POINT
5	OFF	10000 POINT
6	ON	1 CON / 1 PLAY
8	OFF	

X: STANDARD USE
S: BALLOON ADDITION SIDE

B) ADDRESS 5C (B)

NO	ON-OFF	DESCRIPTION
1	ON	NO HIT
1	OFF	HIT DETECT

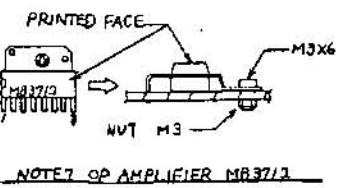
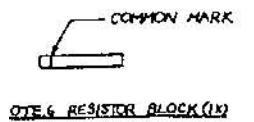
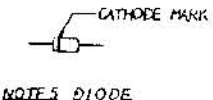
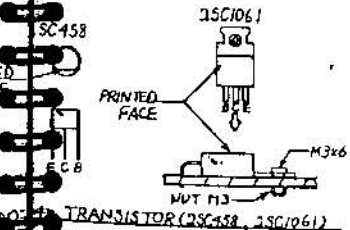
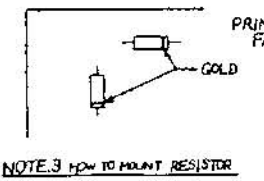
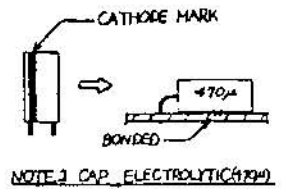
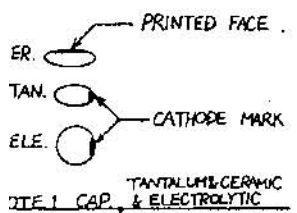

NOTE 8 LS IC (IC5-IC19)
YOU CAN USE IT AS SUBSTITUTION STANDARD IC FOR 'LS IC' ABOUT R1ST SYMBOL NUMBER IC5-IC19

NOTE 9 JUMPER (2 POINT)

NO	JUMPER	PATTERN CUT
J1	1-2	
T4	1-2	1-3

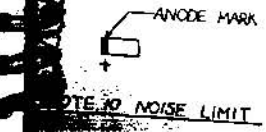

NO.	DESCRIPTION	UNIT
16	AAT4413	TINNED COPPER WIRE 0.5φ
17	AAT4413	CAP CERAMIC 100PF 50V
18	AAT4413	NOISE LIMIT 1500-85
19	R.8	RESISTOR BLOCK 100Ω ELEMENT
20	V.2	VARIABLE RESISTOR A-SOK PHANT
21	V.1	VARIABLE RESISTOR B-SOK
22	R.7B	RES CARBON 1M 1/4W 3.5%
23	R.7	RES CARBON 1M 1/4W 3.5%
24	R.7B	RES CARBON 1M 1/4W 3.5%
25	R.7	RES CARBON 1M 1/4W 3.5%
26	R.7B	RES CARBON 1M 1/4W 3.5%
27	R.7	RES CARBON 1M 1/4W 3.5%
28	R.7B	RES CARBON 1M 1/4W 3.5%
29	R.7	RES CARBON 1M 1/4W 3.5%
30	R.7B	RES CARBON 1M 1/4W 3.5%
31	R.7	RES CARBON 1M 1/4W 3.5%
32	R.7B	RES CARBON 1M 1/4W 3.5%
33	R.7	RES CARBON 1M 1/4W 3.5%
34	R.7B	RES CARBON 1M 1/4W 3.5%
35	R.7	RES CARBON 1M 1/4W 3.5%
36	R.7B	RES CARBON 1M 1/4W 3.5%
37	R.7	RES CARBON 1M 1/4W 3.5%
38	R.7B	RES CARBON 1M 1/4W 3.5%
39	R.7	RES CARBON 1M 1/4W 3.5%
40	R.7B	RES CARBON 1M 1/4W 3.5%
41	R.7	RES CARBON 1M 1/4W 3.5%
42	R.7B	RES CARBON 1M 1/4W 3.5%
43	R.7	RES CARBON 1M 1/4W 3.5%
44	R.7B	RES CARBON 1M 1/4W 3.5%
45	R.7	RES CARBON 1M 1/4W 3.5%
46	R.7B	RES CARBON 1M 1/4W 3.5%
47	R.7	RES CARBON 1M 1/4W 3.5%
48	R.7B	RES CARBON 1M 1/4W 3.5%
49	R.7	RES CARBON 1M 1/4W 3.5%
50	R.7B	RES CARBON 1M 1/4W 3.5%
51	R.7	RES CARBON 1M 1/4W 3.5%
52	R.7B	RES CARBON 1M 1/4W 3.5%
53	R.7	RES CARBON 1M 1/4W 3.5%
54	R.7B	RES CARBON 1M 1/4W 3.5%
55	R.7	RES CARBON 1M 1/4W 3.5%
56	R.7B	RES CARBON 1M 1/4W 3.5%
57	R.7	RES CARBON 1M 1/4W 3.5%
58	R.7B	RES CARBON 1M 1/4W 3.5%
59	R.7	RES CARBON 1M 1/4W 3.5%
60	R.7B	RES CARBON 1M 1/4W 3.5%
61	R.7	RES CARBON 1M 1/4W 3.5%
62	R.7B	RES CARBON 1M 1/4W 3.5%
63	R.7	RES CARBON 1M 1/4W 3.5%
64	R.7B	RES CARBON 1M 1/4W 3.5%
65	R.7	RES CARBON 1M 1/4W 3.5%
66	R.7B	RES CARBON 1M 1/4W 3.5%
67	R.7	RES CARBON 1M 1/4W 3.5%
68	R.7B	RES CARBON 1M 1/4W 3.5%
69	R.7	RES CARBON 1M 1/4W 3.5%
70	R.7B	RES CARBON 1M 1/4W 3.5%
71	R.7	RES CARBON 1M 1/4W 3.5%
72	R.7B	RES CARBON 1M 1/4W 3.5%
73	R.7	RES CARBON 1M 1/4W 3.5%
74	R.7B	RES CARBON 1M 1/4W 3.5%
75	R.7	RES CARBON 1M 1/4W 3.5%
76	R.7B	RES CARBON 1M 1/4W 3.5%
77	R.7	RES CARBON 1M 1/4W 3.5%
78	R.7B	RES CARBON 1M 1/4W 3.5%
79	R.7	RES CARBON 1M 1/4W 3.5%
80	R.7B	RES CARBON 1M 1/4W 3.5%
81	R.7	RES CARBON 1M 1/4W 3.5%
82	R.7B	RES CARBON 1M 1/4W 3.5%
83	R.7	RES CARBON 1M 1/4W 3.5%
84	R.7B	RES CARBON 1M 1/4W 3.5%
85	R.7	RES CARBON 1M 1/4W 3.5%
86	R.7B	RES CARBON 1M 1/4W 3.5%
87	R.7	RES CARBON 1M 1/4W 3.5%
88	R.7B	RES CARBON 1M 1/4W 3.5%
89	R.7	RES CARBON 1M 1/4W 3.5%
90	R.7B	RES CARBON 1M 1/4W 3.5%
91	R.7	RES CARBON 1M 1/4W 3.5%
92	R.7B	RES CARBON 1M 1/4W 3.5%
93	R.7	RES CARBON 1M 1/4W 3.5%
94	R.7B	RES CARBON 1M 1/4W 3.5%
95	R.7	RES CARBON 1M 1/4W 3.5%
96	R.7B	RES CARBON 1M 1/4W 3.5%
97	R.7	RES CARBON 1M 1/4W 3.5%
98	R.7B	RES CARBON 1M 1/4W 3.5%
99	R.7	RES CARBON 1M 1/4W 3.5%
100	R.7B	RES CARBON 1M 1/4W 3.5%

TAITO CORPORATE
 1511 GRADE BALLOON
 C.L. CODE N. BOARD
 ALL RIGHTS RESERVED
 TAITO 00001

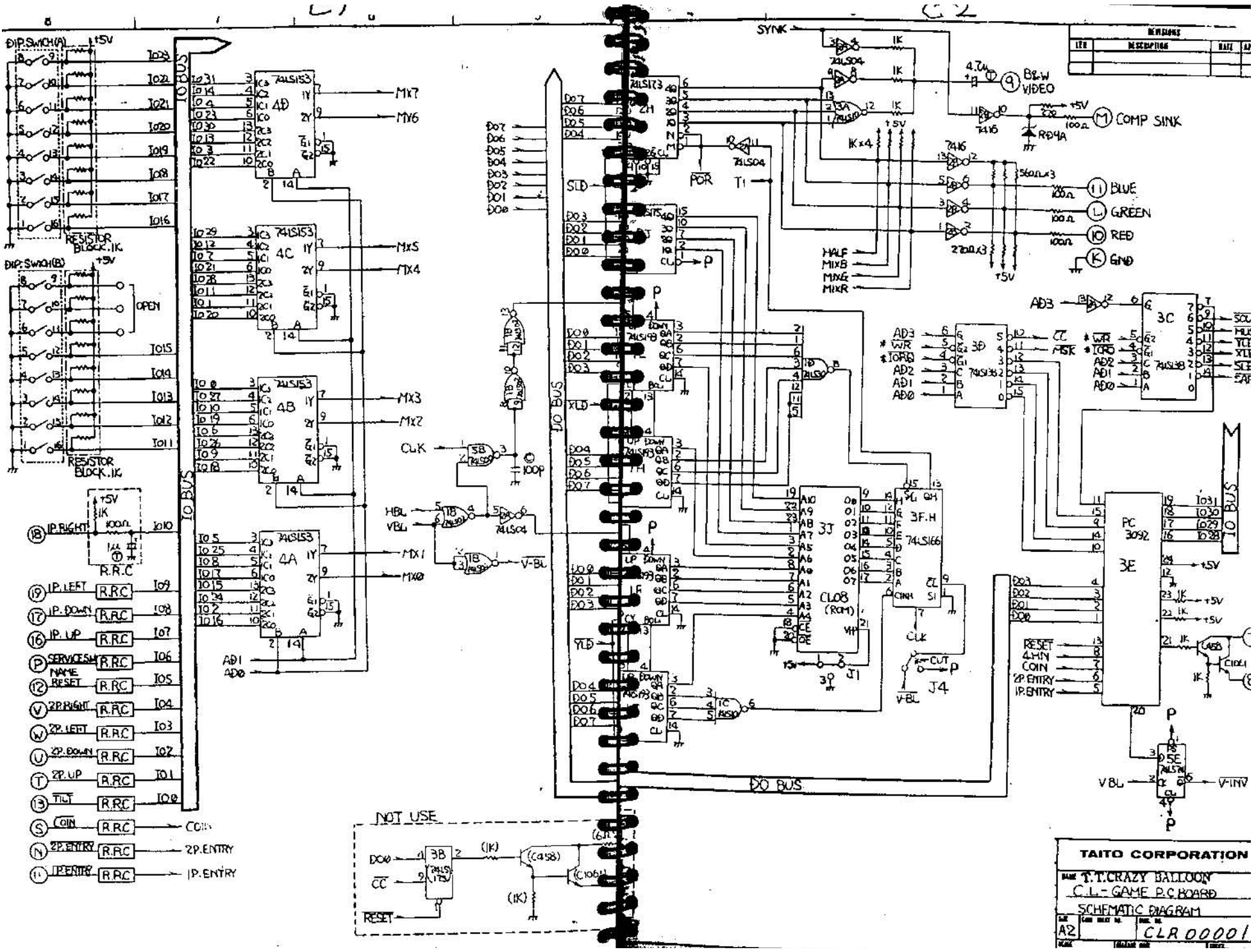

REVISIONS		
REV	DESCRIPTION	DATE

TAITO CORPORATION
 MADE IN JAPAN
 NAME T.T. CRAZY BALLOON
 C.L. - GAME P.C. BOARD
 SCHEMATIC DIAGRAM
 REV. NO. A2
 FILE NO. CLR00001

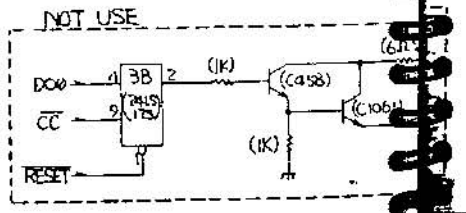

REV	DESCRIPTION	DATE	APPROVED
01	P-27-9-1781	2/15/85	SH

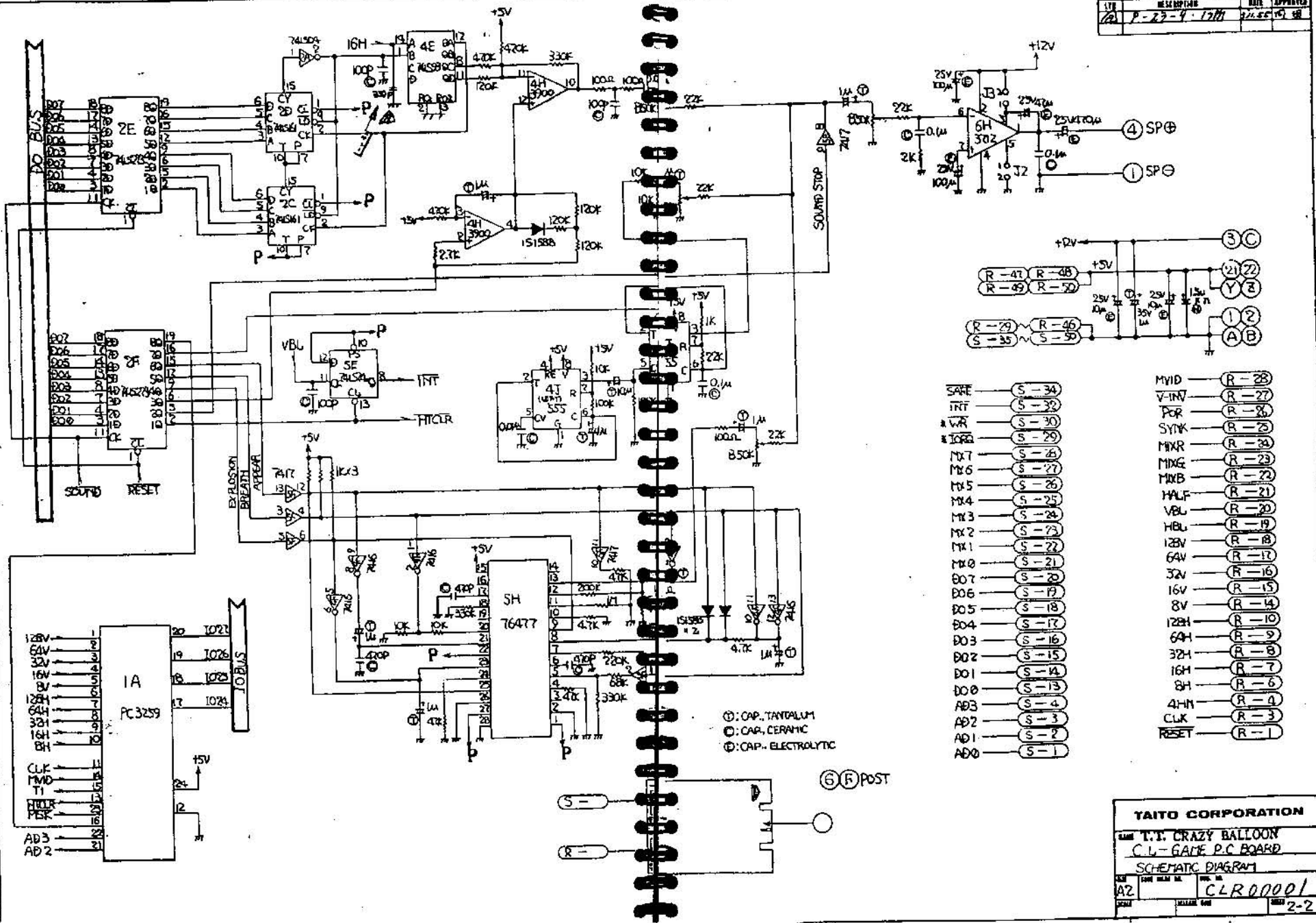

TAITO CORPORATION
 NAME T.T. CRAZY BALLOON
 CL-GAME P.C. BOARD
 SCHEMATIC DIAGRAM
 DATE 8/27/85
 DRAWN BY CLR0001
 CHECKED BY
 SCALE 2-2

E1

E2

310

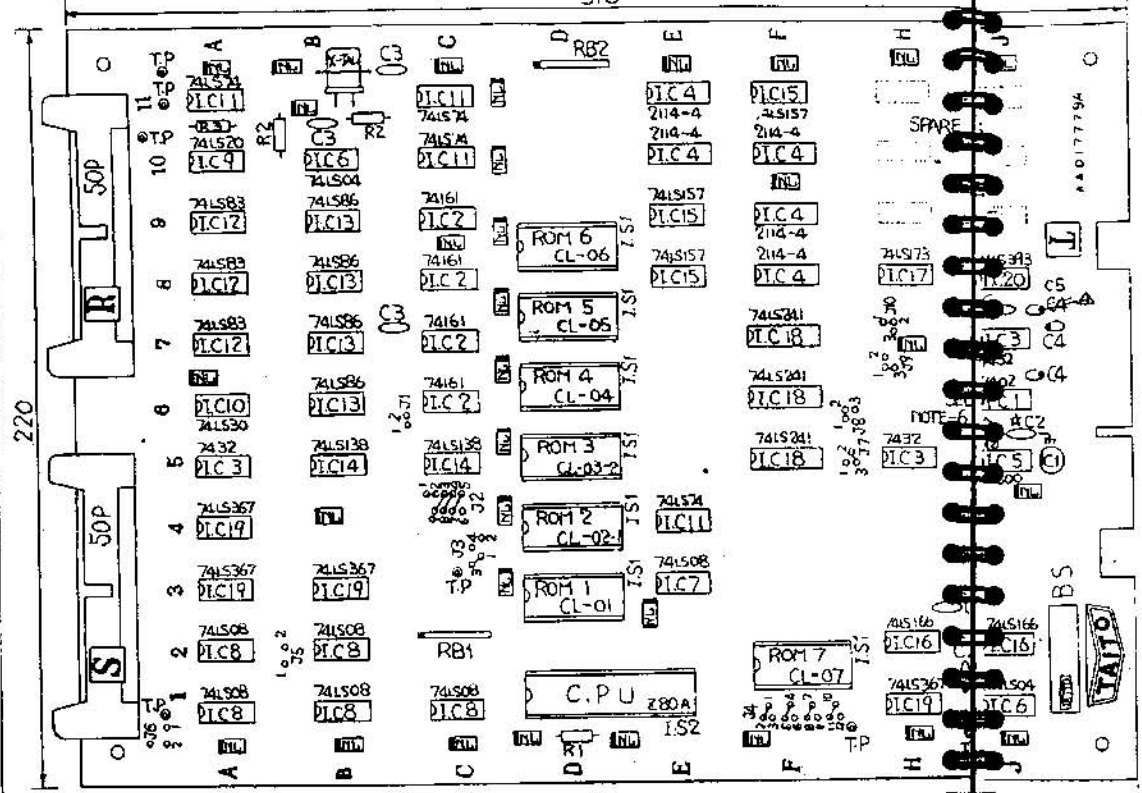

REV	DESCRIPTION	DATE	APPROVED
01	P.23-28.280A15	6.6.84	R.H.

REV	DESCRIPTION	DATE	APPROVED
01	P.23-28.280A15	6.6.84	R.H.

REV	DESCRIPTION	DATE	APPROVED
01	P.23-28.280A15	6.6.84	R.H.

REV	DESCRIPTION	DATE	APPROVED
01	P.23-28.280A15	6.6.84	R.H.

REV	DESCRIPTION	DATE	APPROVED
01	P.23-28.280A15	6.6.84	R.H.

- ELECTROLYTIC
- TANTALUM
- CERAMIC
- NOTE-1. CAP.
- HOW TO MOUNT RESISTOR
- NOTE-2.
- COMMON MARK
- NOTE-3. RESISTOR BLOCK.
- ANODE MARK
- NOTE-4. NOISE LIMIT.

IC ADDRESS	IC / ROM	CONVERT PLACE	JUMPER	JUMPER CUT	DESCRIPTION
3D 4D	2716	J2	1-2	/	
5D 6D			3-9	/	
7D 8D			4-8	/	
3D 4D	2732	J2	2-9	/	
4D			3-8	/	
5D			4-7	/	
1A 2A	7408 or 74125	J 5	1-2	/	0-0 J5
1B 2B	7432 or 74126	J 6	1-2	/	0-0 J6
1C		J 6	1-9	/	0-0 J6

IC ADDRESS	IC / ROM	JUMPER	JUMPER CUT	DESCRIPTION
5E	8728	1-3	2-3	
6E		1-2	1-3	
7E		1-3	1-2	
5F 6F 7F	74521 or 74521	/	/	

NOTE-5. JUMPERS CONVERT WHEN ROM EXCHANGE.

NOTE-6. *C2 IS USED WHEN 9C8 (IC2) IS FAIRCHILD.

PARTS LIST

TAITO CORPORATION

NAME: C.L.-C.P.U. P.C. BOARD ASSY

REV: A2
 DATE: 1/84
 DRAWN: CLN00002

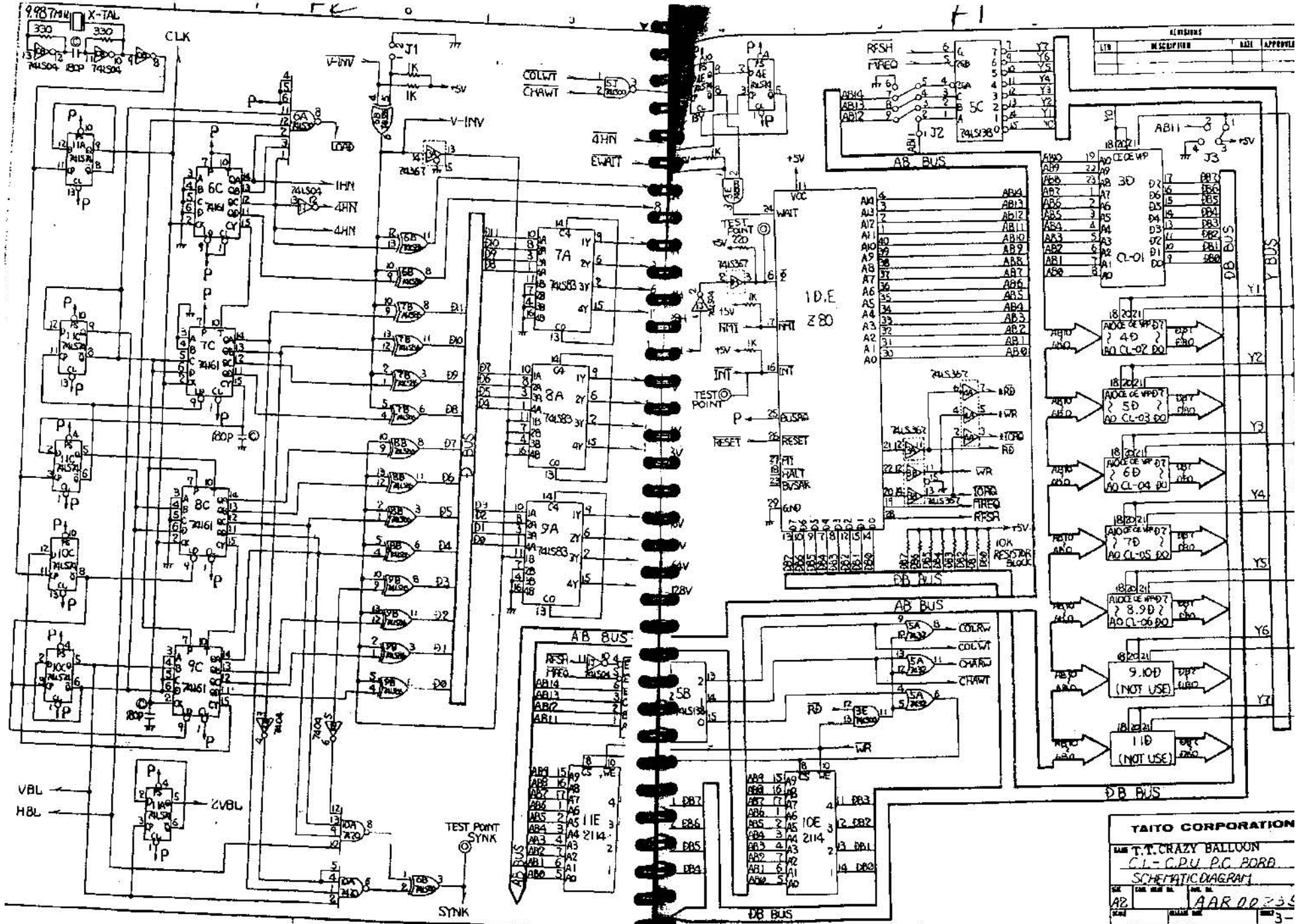

LINE	DESCRIPTION	DATE	APPROVED

TAITO CORPORATION			
T.T. CRAZY BALLOON			
CPU PC BOARD			
SCHEMATIC DIAGRAM			
REV	DATE	BY	CHK
A2		AAR	

82

91

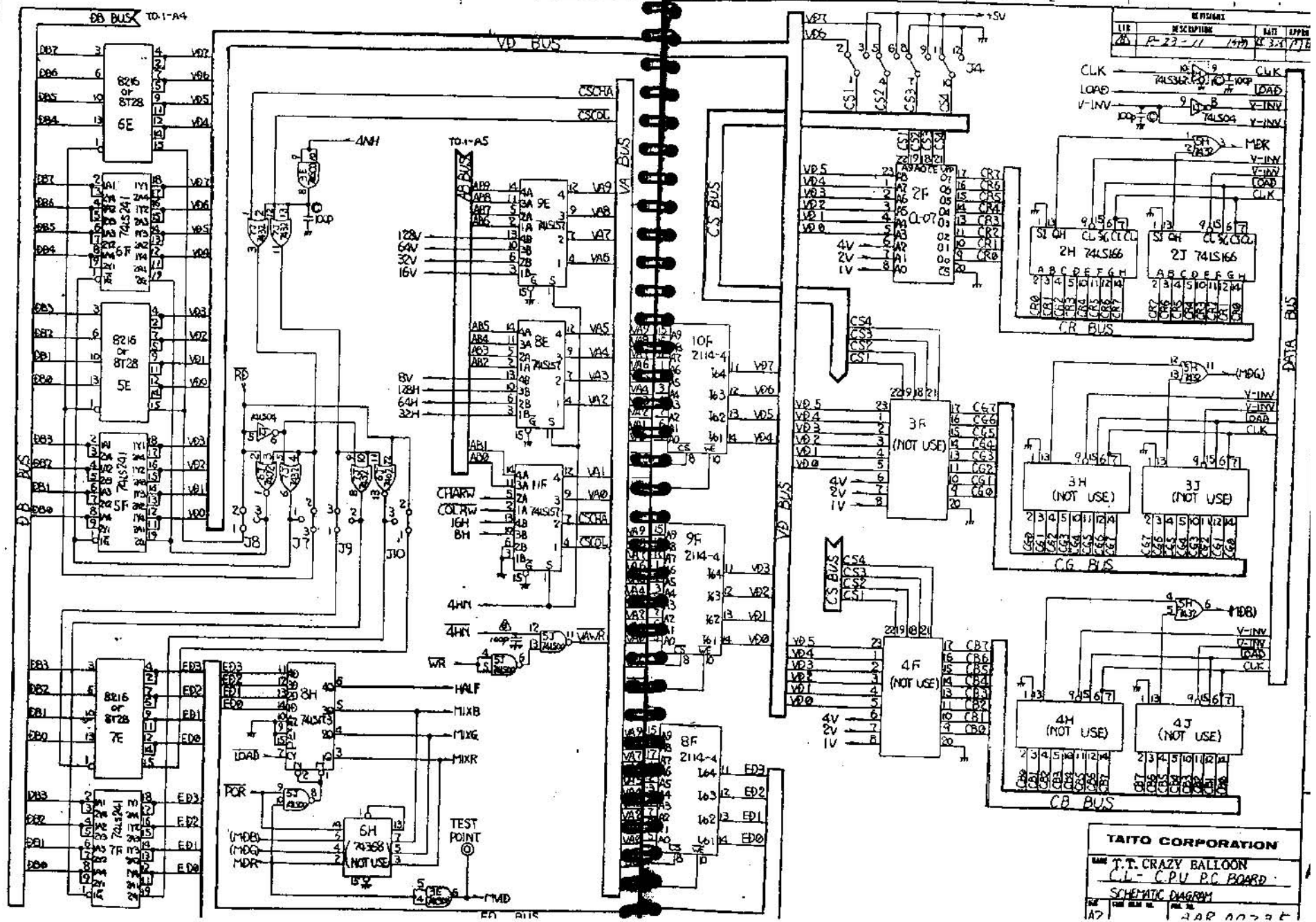

REV	DESCRIPTION	DATE	APP'D
28	P-23-11	1979	R.3.1/PTE

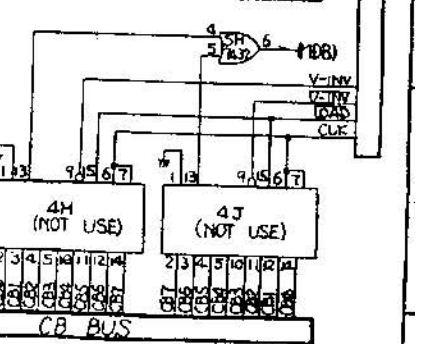
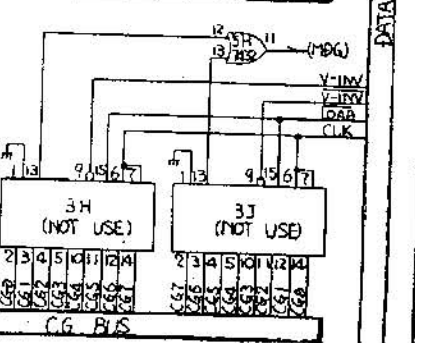
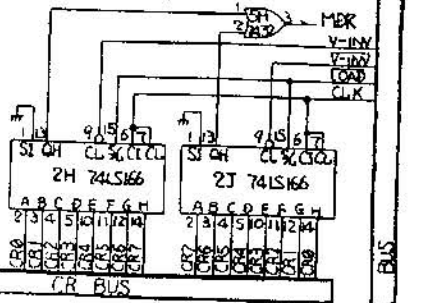
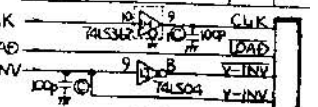

TAITO CORPORATION
 T.T. CRAZY BALLOON
 C.L. - CPU P.C. BOARD
 SCHEMATIC DIAGRAM
 PART NO. 23-11

H2

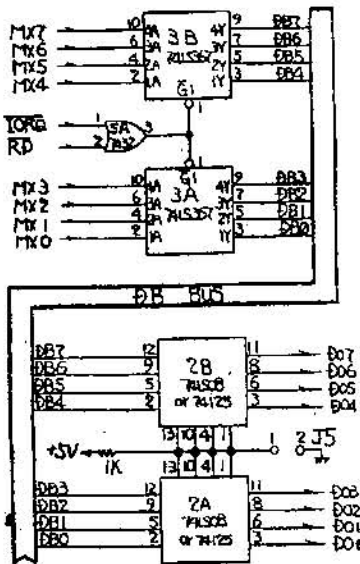

TAB 1

I.C. ADDRESS	ROM	CONVERT PLACE	JUMPER	JUMPER CUT
3D 4D	2716	J2	1-2	/
5D 6D		J2	3-4	/
7D 8D		J3	4-8	/
3B 4B	2732	J2	2-9	/
4B		J2	3-8	/
5B		J3	5-6	1-3

TAB 2

I.C.	CONVERT PLACE	JUMPER	JUMPER CUT
7A 7A08	J5	/	/
7B 7B125	J6	/	/
7C 7C32	J5	1-2	/
7D 7D26	J6	1-2	/

IN PROGRAM

LINE	DESCRIPTION	DATE	APPROVED
1	P-23-1/ 2 PAGES	85.4.26	CHANG
2	P-23-1/ 1 PAGES	85.4.26	CHANG

TAB 3

I.C. ADDRESS	I.C.	CONVERT PLACE	JUMPER	JUMPER CUT
5E	8128	J7	1-3	2-3
6E		J8	1-3	2-3
7E		J9	1-3	2-3
8E		J10	1-3	2-3
5F 6F 7F	74LS241 or 74LS241	J7	/	/
		J8	/	/
		J9	/	/
		J10	/	/

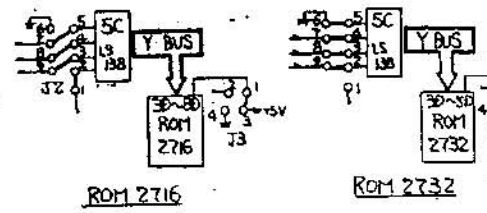

NOTE
 ACCORDING TO I.C.'S TO BE USED,
 DO JUMPER CONNECTORS AND
 TRACECUTTING AS SHOWN 1, 2
 AND 3 TABLE.

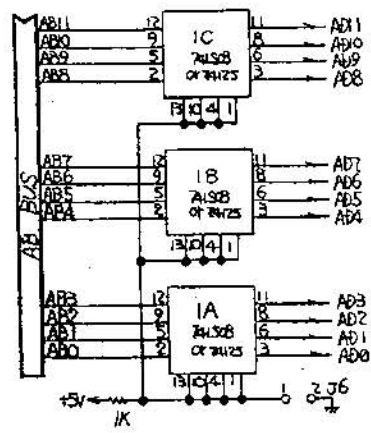

- SAFE — S-34
 - NMI — S-33
 - INT — S-32
 - *RD — S-31
 - *WR — S-30
 - *TORG — S-29
 - MX 7 — S-28
 - MX 6 — S-27
 - MX 5 — S-26
 - MX 4 — S-25
 - MX 3 — S-24
 - MX 2 — S-23
 - MX 1 — S-22
 - MX 0 — S-21
 - DO 7 — S-20
 - DO 6 — S-19
 - DO 5 — S-18
 - DO 4 — S-17
 - DO 3 — S-16
 - DO 2 — S-15
 - DO 1 — S-14
 - DO 0 — S-13
 - AD11 — S-12
 - AD10 — S-11
 - AD9 — S-10
 - AD8 — S-9
 - AD7 — S-8
 - AD6 — S-7
 - AD5 — S-6
 - AD4 — S-5
 - AD3 — S-4
 - AD2 — S-3
 - AD1 — S-2
 - AD0 — S-1
- MVIB — R-20
 - V-INV — R-27
 - POR — R-26
 - SYNC — R-25
 - MNR — R-24
 - MXG — R-23
 - MXB — R-22
 - HALF — R-21
 - VBL — R-20
 - HBL — R-19
 - 120V — R-18
 - 64V — R-17
 - 32V — R-16
 - 16V — R-15
 - 8V — R-14
 - 4V — R-13
 - 2V — R-12
 - 1V — R-11
 - 120H — R-10
 - 64H — R-9
 - 32H — R-8
 - 16H — R-7
 - 8H — R-6
 - 4H — R-5
 - 4HW — R-4
 - CLK — R-3
 - EWAIT — R-2
 - RESET — R-1

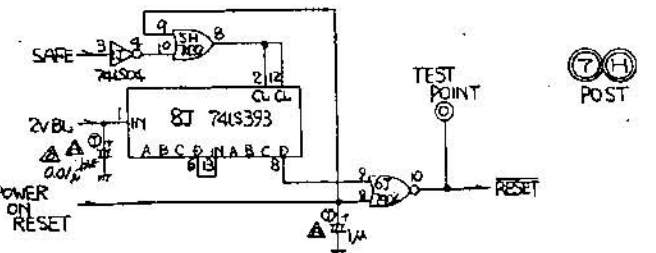
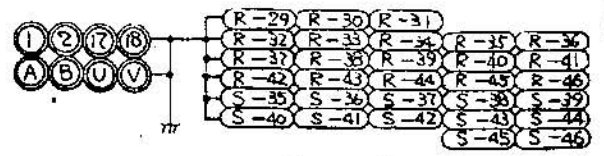
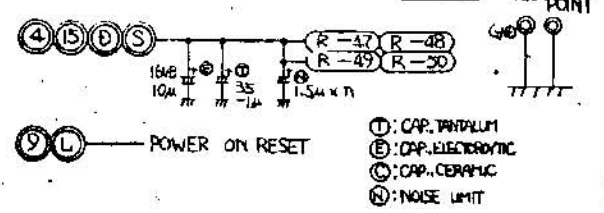
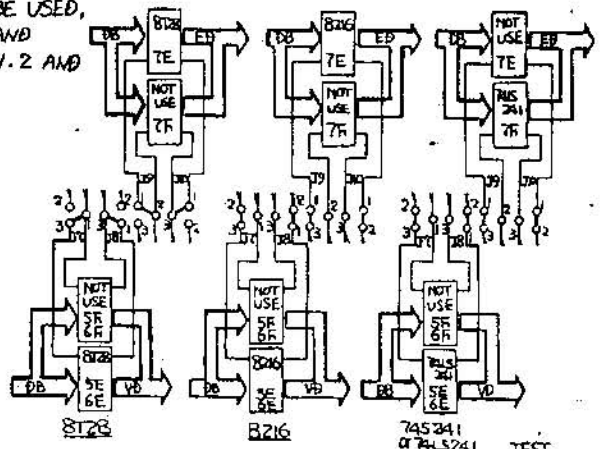

TAITO CORPORATION

MAN T.T. CRAZY BALLOON
 C.L. - C.P.U. P.C. BOARD

SCHEMATIC DIAGRAM

DATE: 85.4.26
 DRAWN: CHANG
 CHECKED: CHANG

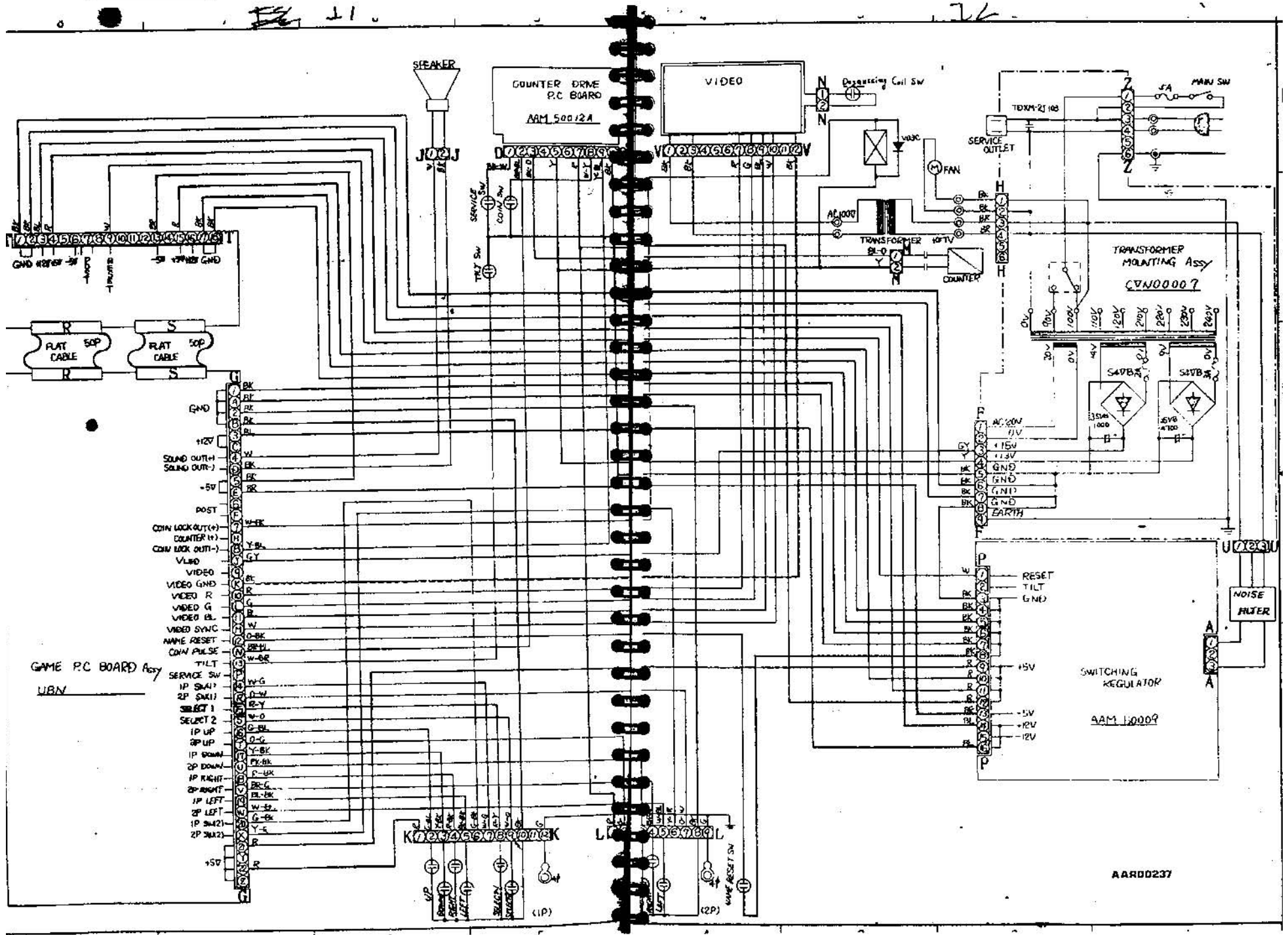

11

12

GAME PC BOARD Assy
UBN

AARD0237